

CS12M

Operators Manual

Klark Teknik Building
Walter Nash Road
Kidderminster
Worcestershire
DY11 7HJ

Tel: +44 (0) 1562 741515

Fax: +44 (0) 1562 745371

Email: info@uk.telex.com

Website: www.ddaconsole.com

CS12M Operators Manual
© Telex Communications (UK) Limited

In line with the company's policy of continual improvement, specifications and function maybe subject to change without notice. This Operator Manual was correct at the time of writing. E&OE.

Contents

Introduction	4
Safety precautions	5
Transport	5
CS12M quickstart	6
CS12M specification	10
CS12M dimensions and wieghts	11
The mono input module	12
The stereo input module	20
The output module	28
The master module	31
The power supply	37
Installation guide	38
Tutorial	41
Recommended auxiliary equipment	49
Glossary	50
Warranty	55
Declaration of Conformity	56

The information in this manual has been carefully verified and is believed to be correct, however, DDA reserves the right to modify the product described in this manual at any time. This document may not be copied or reproduced by any method whatsoever, whether in part or in whole, without the written permission of DDA.

© Copyright 1998 DDA. All rights reserved.

DOC02-CS12/B

INTRODUCTION

The DDA CS12M is a 'Truly' affordable medium format Stage Monitor audio mixing console, allowing a cost-effective upgrade from the dual FOH/Monitor mixing scenario, often seen during smaller performances. CS12M, available with between 16 and 40 inputs, also opens up the possibilities of using Stereo In Ear Monitoring to applications previously restricted by finance.

ALL DDA CS12M consoles include:-

- A customer specified number of mono input modules, each with wide range Mic or Line level input section, a 4 band Equaliser, 12 full-time monitor sends and separate channel level control.
- 4 stereo inputs.
- Pre/Post fader selection switches for added flexibility.
- Front Panel switchable Mono or Stereo monitor send selection.
- A Semi-Modular construction allowing user option setability and future-proof maintenance possibilities.
- Built in Mic Splitter on all inputs.
- 13 Long Throw faders on all monitor outputs and local stereo output.
- Extensive output control allowing individual selection of output phase, talkback selection, AFL Solo and Mute.
- Full Output Metering with the unique 'Bus Peak' indication.
- Full console linkability, allowing any two CS12M consoles to be used as one.
- Global +48 volt phantom power disable, allowing complete and safe control of microphones from the FOH position.

SAFETY PRECAUTIONS

IMPORTANT - PLEASE READ BEFORE INSTALLING YOUR CS12M CONSOLE

Strong sources of electromagnetic radiation e.g. high power cabling, video monitors and radio transmitters may cause degradation of the audio quality due to induced voltages in the chassis and connection leads. Site the console away from such sources. For the same reason it is advisable to site the power supply away from the console.

- Electronic components are susceptible to conditions of excessive heat or extreme cold so take care not to use your console under such conditions.
- Before powering up the console make sure that the power supply voltage selection matches the local mains supply.
- Never connect or disconnect the power cable without switching off the power supply. Similarly switch off the console before removing or servicing modules.
- Do not attempt to wipe clean the console with a cleaning liquid. Most surfaces can be simply cleaned with a soft dry brush. Should the chassis or channel ident strips need cleaning use only water or isopropyl alcohol. Solvent based products should not be used as they may damage these parts.
- Use a wax based crayon to write on the scribble strips. The use of adhesive backed tapes may damage the screen printing on the modules.

TRANSPORT

It is recommend that you retain all the packing from your console should you ever need to return it for service or move the console to other premises.

If the console has to be moved regularly then we suggest that you purchase a foam lined flight case, available from your distributor if you cannot purchase one locally.

Only use the power supply and cables provide. Your warranty is invalidated if other supplies or cables are used.

If you experience any problem with the local mains, or during thunder storms, switch off the power supply and unplug it from the mains supply.

CS12M QUICKSTART

For this you should have the following items available.

- Microphone and cable.
- Power amplifier with mains cord and signal cable.
- Loudspeaker with connecting cable.
- Headphones.
- CS12M console with power supply.

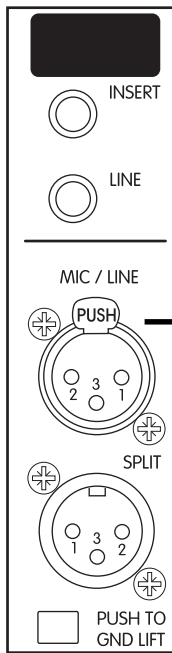

First of all make sure that the power supply is suitable for connection to your local supply and then connect the console to the power supply. Connect your loudspeaker(s) to the amplifier and set the volume control(s) to a low level.

Connect the microphone into channel 1 and the power amplifier into Monitor Send 1 Output.

Switch ON the console BEFORE switching on the power amplifier.

Check that the leds on the master module illuminate for the +/- 18V and +48V power rails. If phantom power is required for your microphone then ensure that the +48V ON led is illuminated. If not use a blunt non conducting instrument such as a pencil or pen to push the switch which is located under the panel.

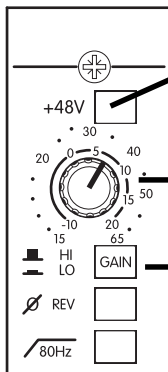
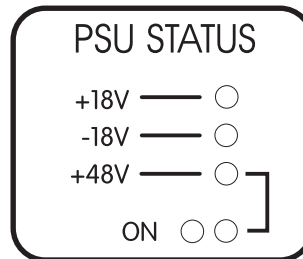

Press the +48V switch on the input module if phantom power is required, for a condenser mic or DI box.

INPUT GAIN

Select hi gain on channel 1 by having the GAIN switch in the UP position.

Turn up the INPUT GAIN control on channel 1 until the signal present led is on but not so high that the peak led is on when speaking into the microphone.

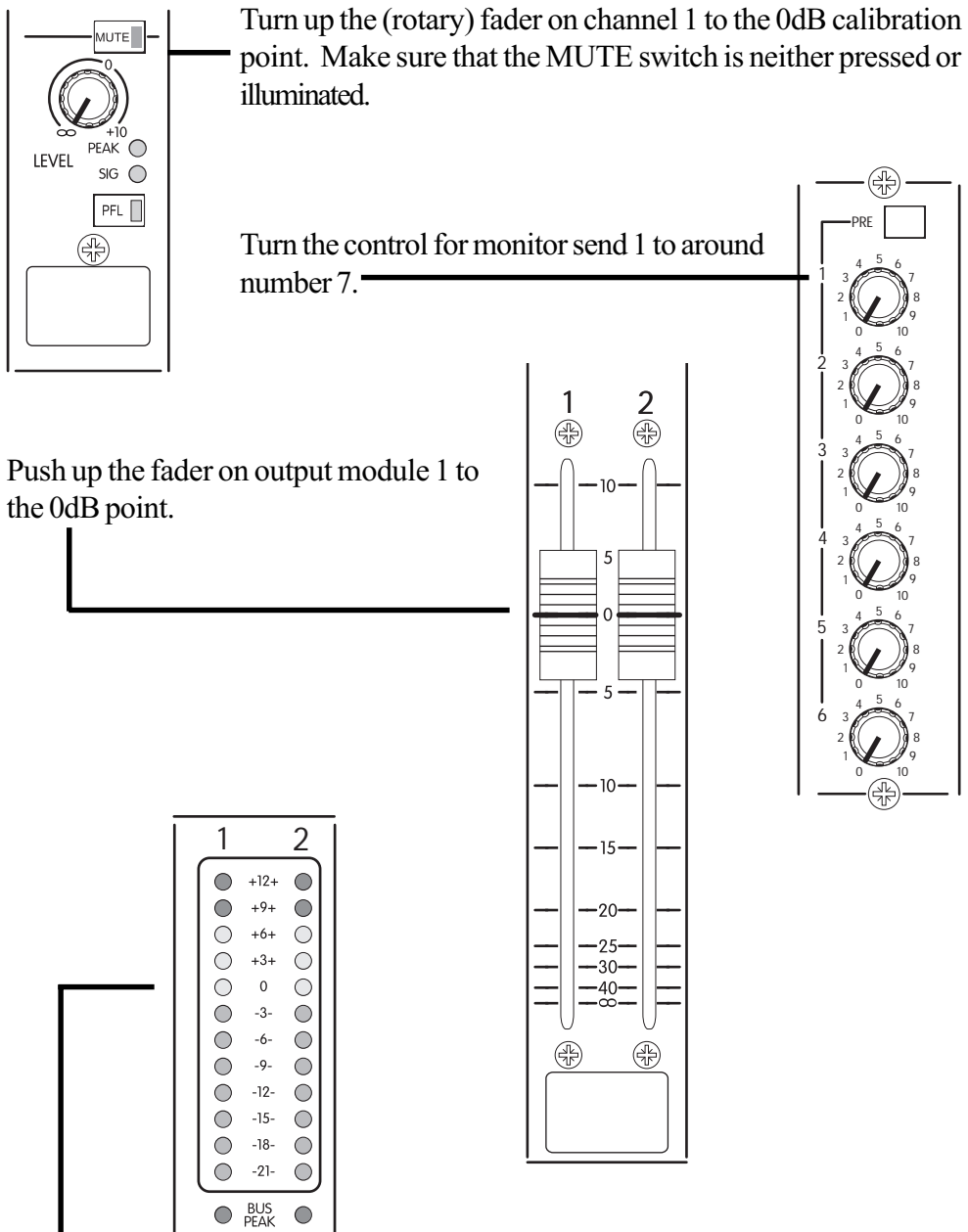

Look for signal on the group output meter by speaking into the microphone. The level should be around +6dB with occasional flashing of the red leds. The BUS PEAK leds should not flash. If the level is too low then re-adjust the input gain control on the input module.

Ideally the input fader should remain close to the 0dB point with the SIGNAL PRESENT led ON. The PEAK led should not be indicating other than very occasionally. If the input level is too high then reduce the gain with the INPUT GAIN control.

If the power amplifier and loudspeaker are connected to this output you will then hear yourself from the loudspeaker (beware of feedback).

Do not attempt to plug microphones into these connectors. They are used to plug LITTLITES™ into and will damage a microphone.

Press the PFL key on the input module and observe the left hand meter on the master module. It will show the pre fader signal from the input module.

This can only be changed by adjustment of the INPUT GAIN control.

Cancel the input PFL and press AFL on output module 1 to observe the output signal. This will change if the INPUT GAIN, INPUT FADER or OUTPUT FADER are adjusted.

Plug headphones into the headphone socket located below the armrest and turn up the volume to hear the selected AFL (or PFL) signal.

Congratulations — it's all working the way it should.

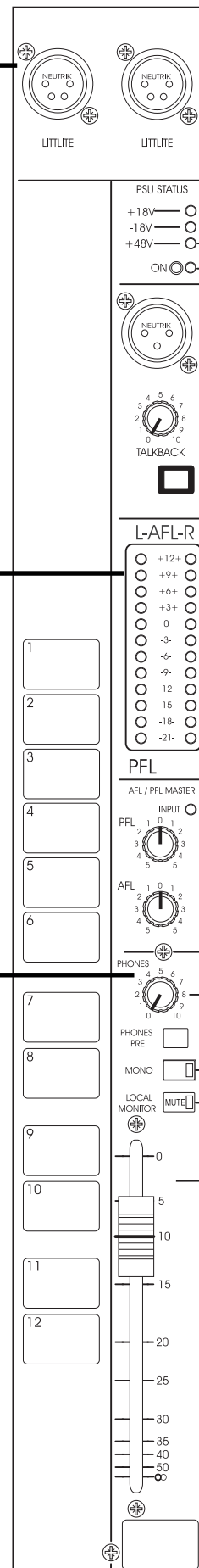

This drawing illustrates the simple quick start set up.

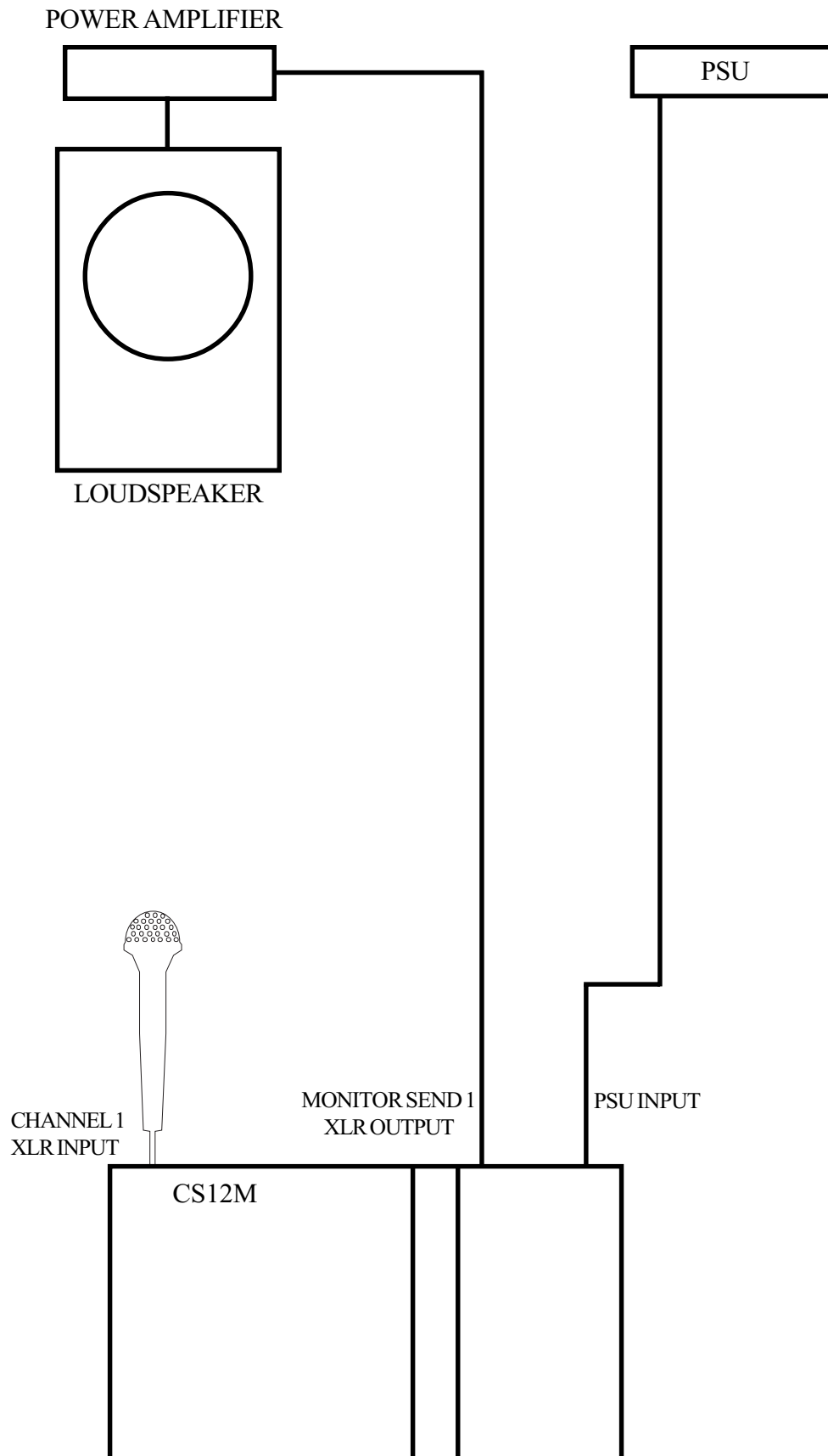

CS12M SPECIFICATIONS

Nominal Operating Level +4dBu with a unity gain structure.

Frequency Response 20Hz - 20kHz +/-0.5dB any input to any output at a gain < 50dB.

EQ range

HF +/-15dB @ 10kHz shelving

Hi Mid +/-15dB 470Hz - 15kHz, Q = 1.4

Lo Mid +/-15dB 70Hz - 2.2kHz, Q = 1.4

LF +/-15dB @ 100Hz shelving

Hi Pass Filter, 80Hz, 18dB/octave roll off

Channel Mute Attenuation > 90dB @ 1kHz

Input Monitor Send Attenuation > 85dB @ 1kHz

Distortion

0.005% @1kHz any input to any output at a gain < 50dB.

Noise: -82dBu (24 channels routed and muted)

EIN: -127.5dBu ref 200 ohms

EIN: -128.7dBu ref 150 ohms

Maximum output level: +20dBu into a bridging load

Maximum input level: +30dBu

Input Impedance: >2kohm

Output impedance: <75R

Signal present threshold: -21dBu

Peak led threshold: 3dB below clipping

Power consumption: < 300 Watts

CS12M DIMENSIONS AND WEIGHTS

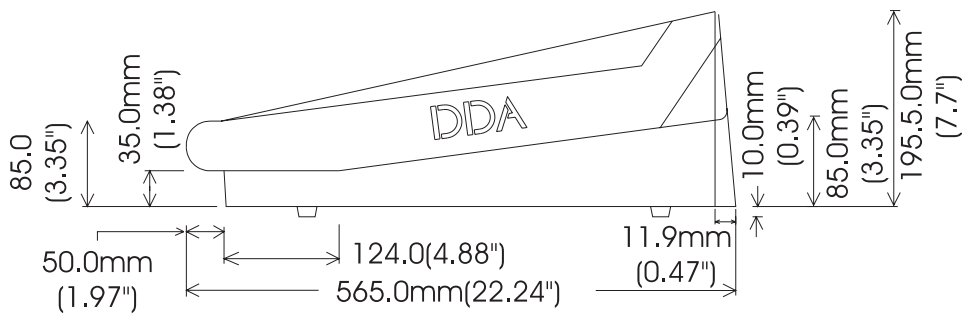
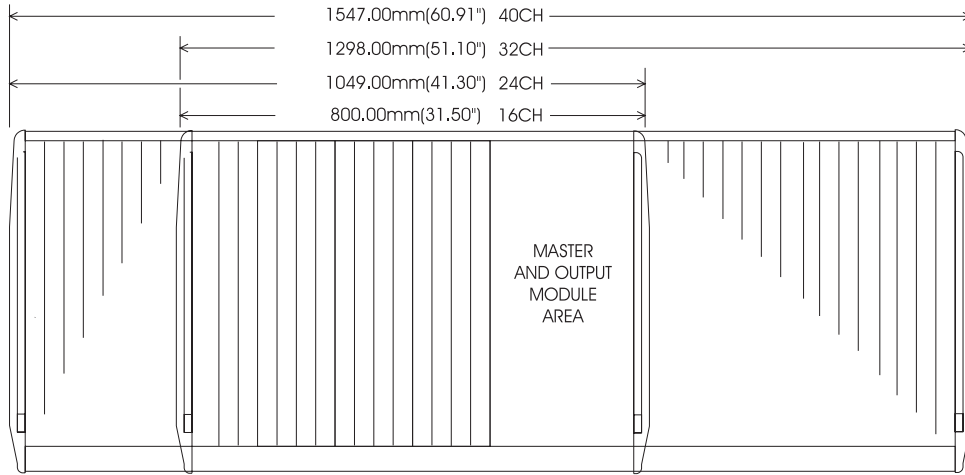

CONSOLE WEIGHTS AND DIMENSIONS

	(Unpacked)	(Packed)	Dimensions
16	22kg/48.5lbs	30kg/66.1lbs	104 x 65 x 30 cms 40.9 x 25.6 x 11.8 inches
24	26.6kg/58.7lbs	40kg/88.2lbs	129 x 65 x 30 cms 50.8 x 25.5 x 11.8 inches
32	31.2kg/68.8lbs	50kg/110.2lbs	154 x 65 x 30 cms 60.6 x 25.6 x 11.8 inches
40	35.8kg/79lbs	60kg/132.3lbs	180 x 62 x 40 cms 70.9 x 24.4 x 15.7 inches

POWER SUPPLY DIMENSIONS

This is a 2U high rack mounting box with a depth of 172mm/6.75".

PSU Weight: 5kg/11lbs

THE MONO INPUT MODULE

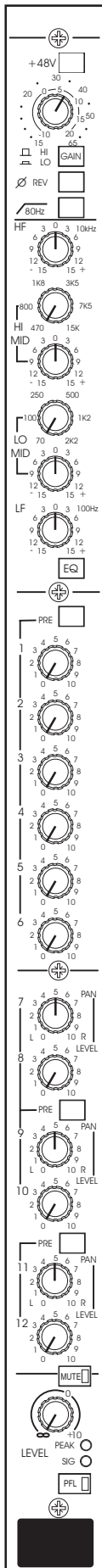

The mono input module contains a high quality balanced input stage that is used for the microphone and line input signals.

This stage is followed by a High Pass Filter, Equaliser and Insert Point before the signal is passed through the channel fader to become available for the monitor send buses. The pre equaliser and the pre fader signals can also be used to feed the monitor sends depending upon the operational circumstances.

A total of 12 Monitor Sends are available, 6 of which can be switched for stereo operation, the two level controls forming a PAN and LEVEL pair.

PEAK and SIGNAL PRESENT leds assist in setting the pre-fade signal level and the signal may be metered and listened to using the PFL facility.

THE MONO INPUT MODULE

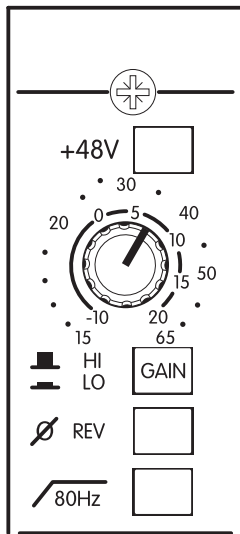

+48V

Provides 48 volt phantom power for a condenser microphone, or D.I. box. The 48V ON switch on the master module must be ON for phantom power to operate. Optional balancing transformers may be fitted to the Mic/Line Inputs.

GAIN POTENTIOMETER

The gain control is a wide range rotary potentiometer which is active on both Mic and Line Inputs. With Hi gain selected the gain can be adjusted from 15dB to 65dB. For Lo gain inputs, the adjustment is from -10dB to +20dB.

HI/LO GAIN

Pressing this inserts an attenuator into the input circuit and alters the range of gain adjustment available. This should be pressed when high level or line level signals are connected to the channel through the line input jack. Note that if a jack is not inserted into the line input socket then the XLR connector may be used as the line input. The TRS jack could also be used as a microphone input although this is not recommended and phantom power will not be available.

Ø REV

Pressing this reverses the phase (or more correctly the polarity) of the input signal. If a sound source is picked up by more than one microphone and there is a phase or polarity difference between the microphones then the signal may be completely or partially cancelled leading to a very thin sound. Phase or polarity reversal can be used to correct the situation. In some instances the cancellation induced by using polarity reversal can be used constructively to eliminate spill from one microphone to another although care is required when trying this.

80Hz

This inserts an 80Hz highpass filter with a rolloff of 18dB per octave into the signal path after the input amplifier. This may be used to eliminate unwanted low-frequency noises transmitted to the microphone through a floorstand for example.

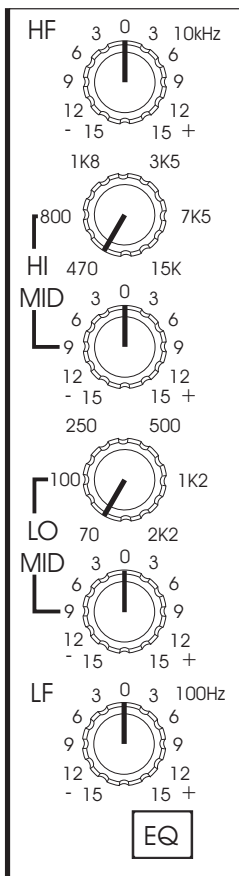

THE EQUALISER

The equaliser is a 4 band design with shelving high and low sections in addition to two swept mid frequency sections. All sections have a range of +/-15dB.

HF

A shelving high frequency equaliser operating at 10kHz which can be used to boost or cut the high frequency content of the signal.

HI MID

A peaking equaliser which can be used to boost or cut signal within the frequency range 470Hz to 15kHz with a Q of 1.4.

LO MID

A peaking equaliser which can be used to boost or cut signal within the frequency range 70Hz to 2.2kHz with a Q of 1.4.

LF

A shelving low frequency equaliser operating at 100Hz which can be used to boost or cut the low frequency content of the signal.

EQ

This switch inserts the equaliser into the signal path. If the equaliser is not required then noise and distortion, although very low, can be minimised by ensuring that the equaliser is not switched into circuit. If the equaliser is used then an immediate comparison between the unequalised and equalised sound is made possible by using this switch.

INSERT

Although there is no front panel control the insert point follows the equaliser. With nothing plugged into the insert jack signal is simply passed through to the channel fader. When a jack is inserted the signal path is broken and signal is forced to flow through an external device before returning to the module. The insert return signal is used to operate the PEAK and SIG leds.

EQUALISATION AND FILTER RESPONSES

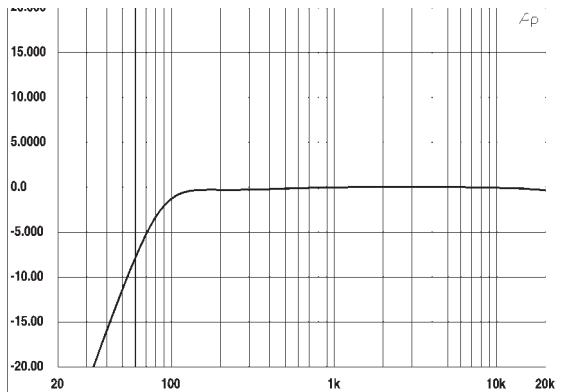

HIGH PASS FILTER

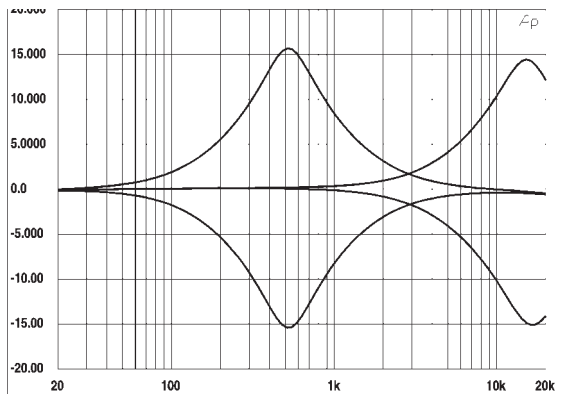

HI MID EQUALISER

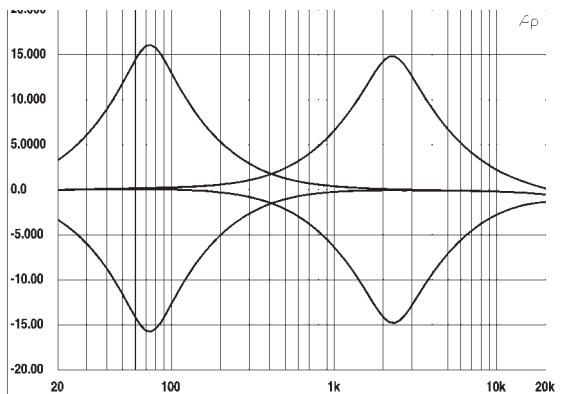

LO MID EQUALISER

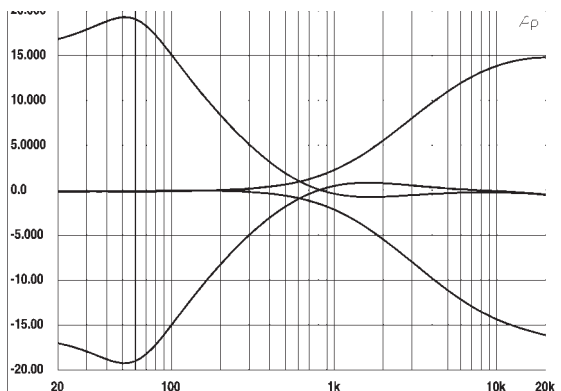

HF/LF EQUALISER

THE MONITOR SENDS 1—12

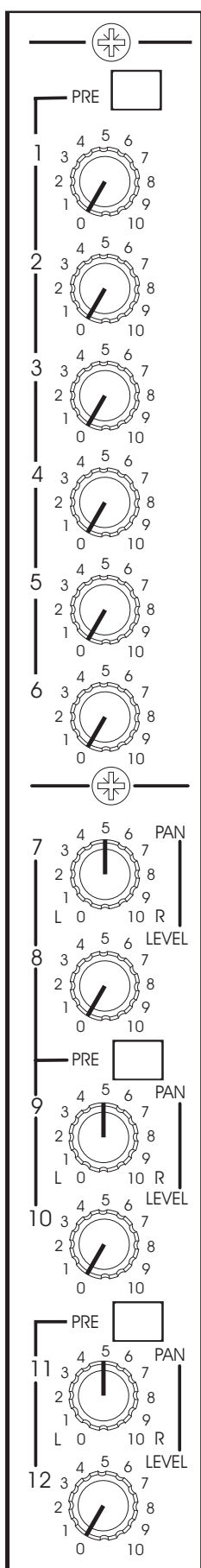

There are 12 monitor sends six of which can be used as stereo pairs or individual mono sends. All sends are post fade until a PRE switch is pressed. There are three PRE switches covering sends 1-6, 7-10 and finally 11-12.

MONITOR SENDS 1/2/3/4/5/6/7/8/9/10/11/12

These controls adjust the signal level to the individual monitor sends. Thus to send more signal to Monitor Send 2 simply turn up the control. Note that these monitor sends normally receive the POST FADE signal and that the PRE switch must be pressed to obtain a pre fade signal.

Monitor sends 7 through 12 can be used as stereo sends by pressing the STEREO switch on the output module and in this case the odd numbered control, for example number 7, will be used to pan the mono signal across the stereo output. The even numbered control, for example number 8, will be used as the level control.

PRE 1-6

This sends a prefade signal to Monitors 1 through 6. Normally internal link 7 will be installed giving a pre fade post mute signal. Removing link 7 and inserting link 8 allows a pre equaliser signal to be sent.

PRE 7-10

This sends a prefade signal to Monitors 7 through 10. Normally internal link 3 will be installed giving a pre fade post mute signal. Removing link 3 and inserting link 4 allows a pre equaliser signal to be sent.

PRE 11-12

This sends a prefade signal to Monitors 11 and 12. Normally internal link 5 will be installed giving a pre fade post mute signal. Removing link 5 and inserting link 6 allows a pre equaliser signal to be sent.

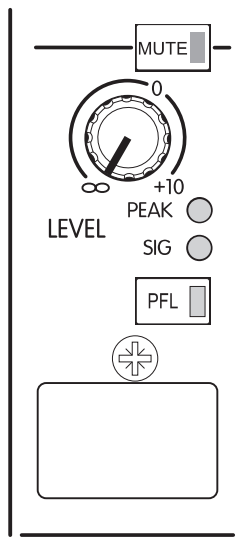

THE CHANNEL FADER

MUTE

When pressed this mutes the POST FADE signal and any POST FADE monitor sends.

LEVEL

This rotary control adjusts the post fade signal level within the module. Any monitor send receiving the post fade signal will be dependent upon this fader.

PEAK

This illuminates when the signal level is too high and close to being clipped. Clipping is a severe form of distortion and indicates that the input gain of the module should be reduced.

SIG

This illuminates in the presence of signal and may be a useful diagnostic aid in the event of any problems.

PFL

This allows the module signal to be listened to in isolation on the monitoring system. If pressed when an output AFL is active the output will be muted so that the input can be heard. When the input PFL is released the output AFL will be returned to the local monitor. This is known as input priority.

MONO INPUT CONNECTOR AND PIN DEFINITIONS

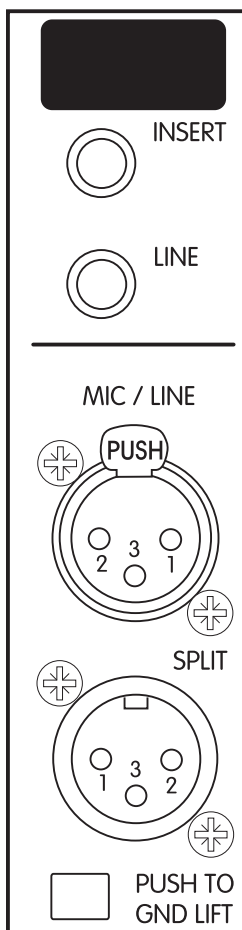

Mic Line Input : 3 Pin Female XLR type,
Balanced Pin 2 “Hot”
Nominal Input Level: -16dBu to -66dBu
Pin 2 : Signal +ve (Hot)
Pin 3 : Signal -ve (Cold)
Pin 1 : Ground
Input Impedance : >2 kOhm

Split Output : 3 Pin Male XLR type,
Balanced Pin 2 “Hot”
Nominal Output Level: -16dBu to -66dBu
Pin 2 : Signal +ve (Hot)
Pin 3 : Signal -ve (Cold)
Pin 1 : Ground

Line Input : 1/4" TRS Jack Socket, ‘A’ Gauge, Balanced
Nominal Input Level: -16dBu to +14dBu
Tip : Signal +ve (Hot)
Ring : Signal -ve (Cold)
Sleeve: Ground
Input Impedance : >10 kOhm

Insert Point :	1/4" TRS Jack Socket, ‘A’ Gauge, Unbalanced
Nominal Input/Output level:	0dBu
Tip:	Insert Send
Ring:	Insert Return
Sleeve:	Ground
Output Impedance:	<75 Ohm
Input Impedance :	>10 kOhm

The GROUND LIFT switch isolates both the Microphone Input and the Split connector from the console ground. It may be of use when the split connector is feeding a front of house console when there is a great danger of ground loops being formed.

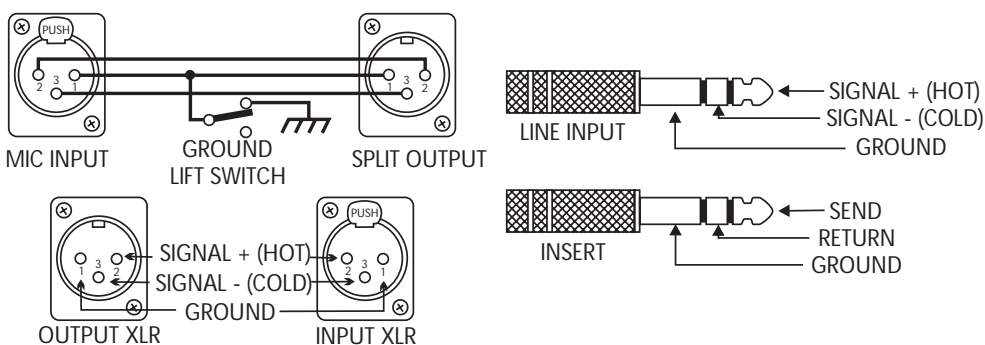

MONO INPUT MODULE BLOCK DIAGRAM

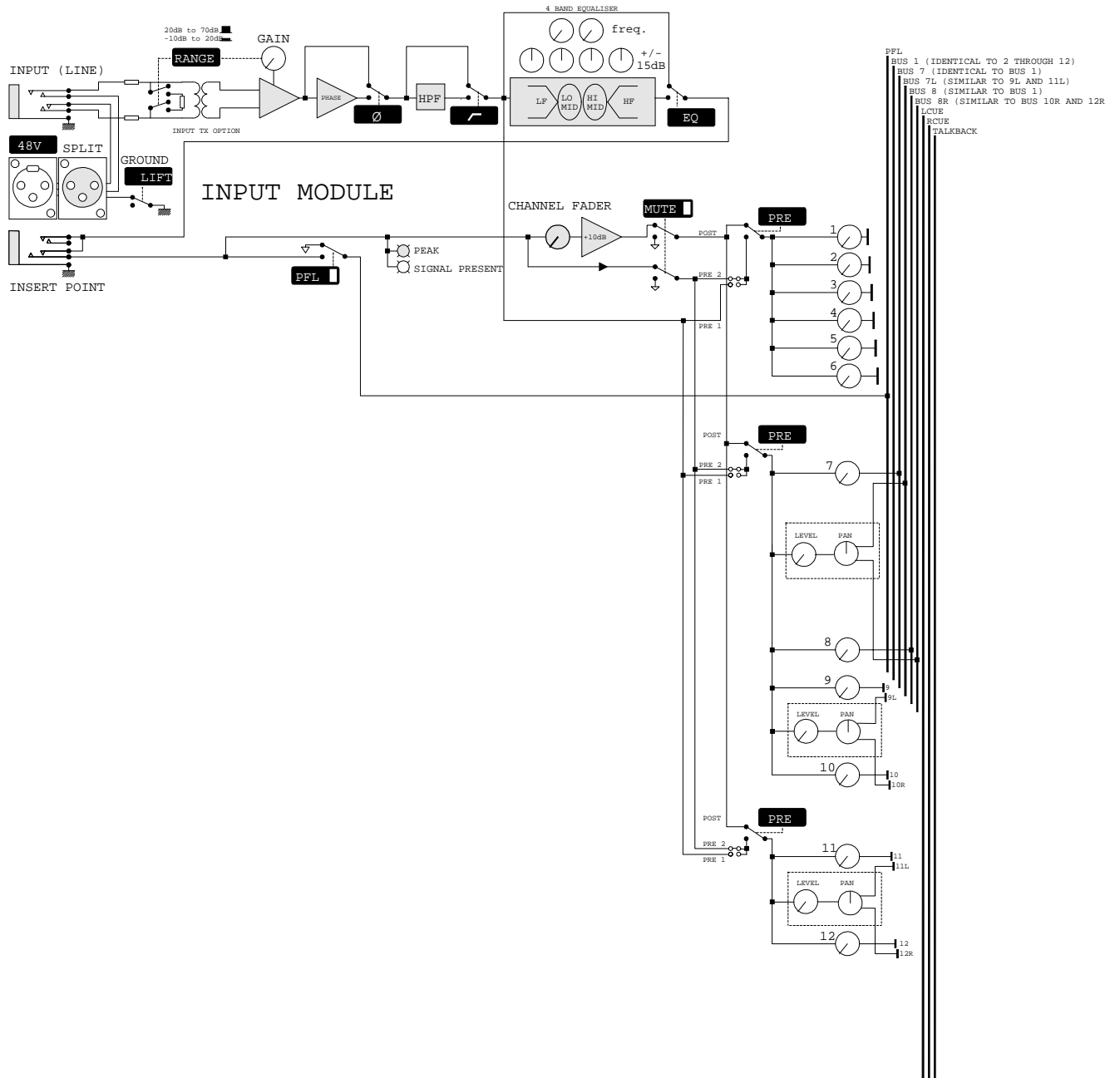

THE STEREO INPUT MODULE

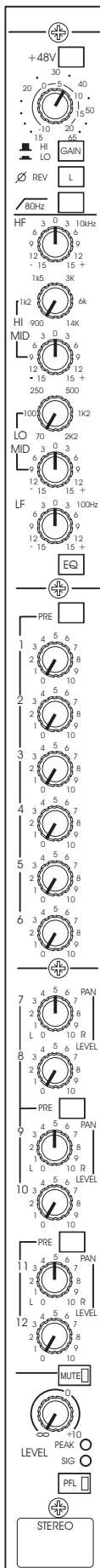

The stereo input module contains a high quality balanced input stage that is used for the microphone and line input signals.

This stage is followed by a High Pass Filter, Equaliser and Insert Point before the signal is passed through the channel fader to become available for the monitor send buses. The pre equaliser and the pre fader signals can also be used to feed the monitor sends depending upon the operational circumstances.

A total of 12 Monitor Sends are available, 6 of which can be switched for stereo operation, the two level controls forming a PAN and LEVEL pair.

PEAK and SIGNAL PRESENT leds assist in setting the pre-fade signal level and the signal may be metered and listened to using the PFL facility.

The stereo input module allows stereo mic or line level signals to be fed from, for Example:

- Keyboards.
- Stereo Overhead drum microphones.
- Stereo snare drum microphones.
- Audience ambient microphones for in-hear use.
- Effect returns.

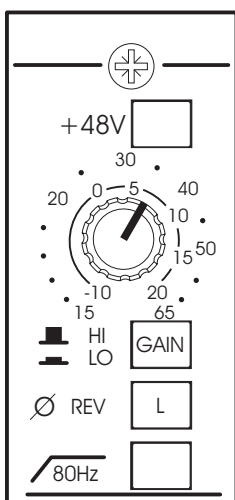

+48V

Provides 48 volt phantom power for a condenser microphone, or D.I. box. The 48V ON switch on the master module must be ON for phantom power to operate. Optional balancing transformers may be fitted to the Mic/Line Inputs.

GAIN RANGE

The gain control is a wide range rotary potentiometer which is active on both Mic and Line Inputs. With Mic selected the gain can be adjusted from 15dB to 65dB. For Line inputs, the adjustment is from -10dB to +20dB.

HI/LO GAIN

Pressing this inserts an attenuator into the input circuit and alters the range of gain adjustment available. This should be pressed when high level or line level signals are connected to the channel through the line input jack. Note that if a jack is not inserted into the line input socket then the XLR connector may be used as the line input. The TRS jack could also be used as a microphone input although this is not recommended and phantom power will not be available.

Ø REV

Pressing this reverses the phase (or more correctly the polarity) of the left input signal. If a sound source is picked up by more than one microphone and there is a phase or polarity difference between the microphones then the signal may be completely or partially cancelled leading to a very thin sound. Phase or polarity reversal can be used to correct the situation. In some instances the cancellation induced by using polarity reversal can be used constructively to eliminate spill from one microphone to another although care is required when trying this. On the stereo input the Ø reverse switch can be used to compensate for opposing microphone techniques, for example 2 mics on the top and bottom of a snare drum.

80Hz

This inserts an 80Hz highpass filter with a rolloff of 18dB per octave into the signal path after the input amplifier. This may be used to eliminate unwanted low-frequency noises transmitted to the microphone through a floorstand for example.

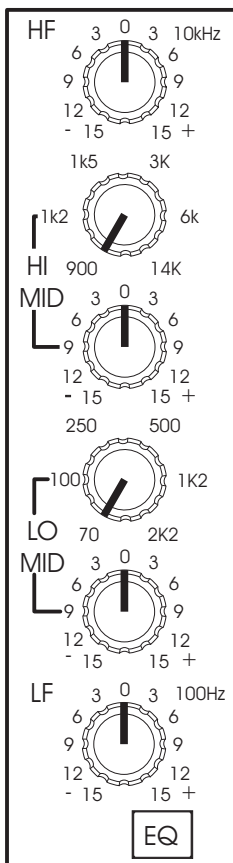

THE EQUALISER

The equaliser is a 4 band design with shelving high and low sections in addition to two swept mid frequency sections. All sections have a range of +/-15dB.

HF

A shelving high frequency equaliser operating at 10kHz which can be used to boost or cut the high frequency content of the signal.

HI MID

A peaking equaliser which can be used to boost or cut signal within the frequency range 900Hz to 14kHz with a Q of 1.4.

LO MID

A peaking equaliser which can be used to boost or cut signal within the frequency range 70Hz to 2.2kHz with a Q of 1.4.

LF

A shelving low frequency equaliser operating at 100Hz which can be used to boost or cut the low frequency content of the signal.

EQ

This switch inserts the equaliser into the signal path. If the equaliser is not required then noise and distortion, although very low, can be minimised by ensuring that the equaliser is not switched into circuit. If the equaliser is used then an immediate comparison between the unequalised and equalised sound is made possible by using this switch.

EQUALISATION AND FILTER RESPONSES

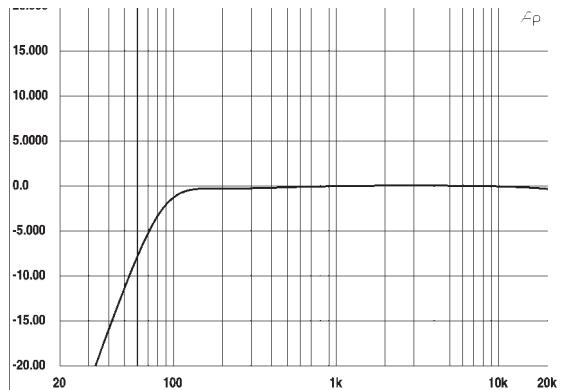

HIGH PASS FILTER

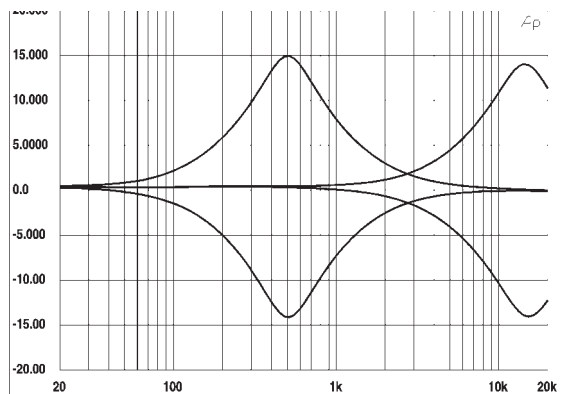

HI MID EQUALISER

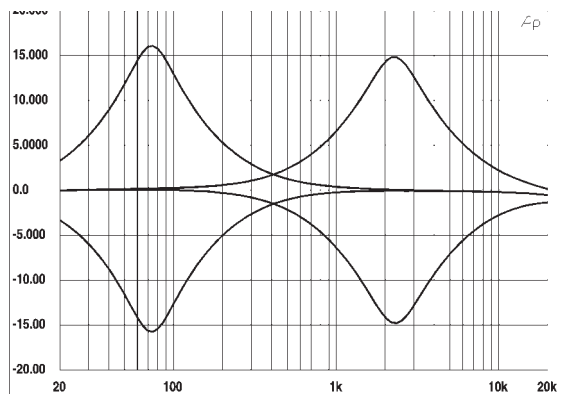

LO MID EQUALISER

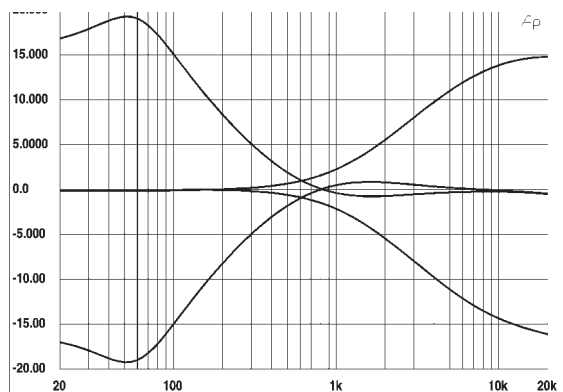

HF/LF EQUALISER

THE MONITOR SENDS 1—12

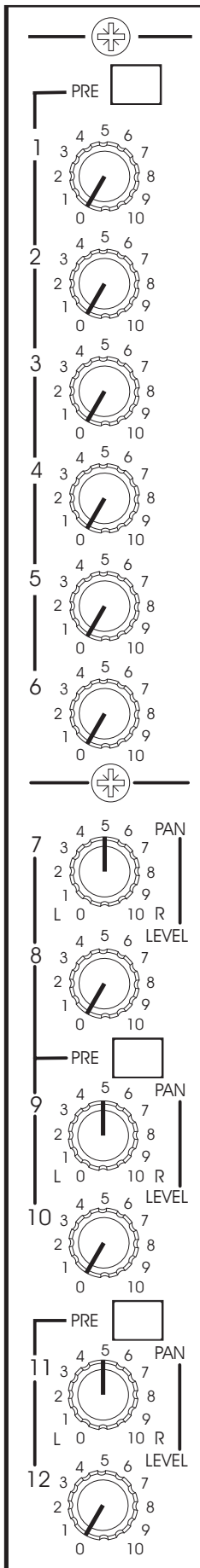

There are 12 monitor sends six of which can be used as stereo pairs. All sends are post fade until a PRE switch is pressed. There are three PRE switches covering sends 1-6, 8-10 and finally 11-12.

MON 1/2/3/4/5/6

These controls adjust the signal level to the individual monitor sends. Thus to send more signal to Monitor Send 2 simply turn up the control. Note that these monitor sends normally receive the POST FADE signal and that the PRE switch must be pressed to obtain a pre fade. A mono sum of the left and right inputs are always fed to monitor sends 1-6.

MON 7/8/9/10/11/12

These controls adjust the signal level to the individual monitor sends. Thus to send more signal to Monitor Send 7 simply turn up the control. Note that these monitor sends normally receive the POST FADE signal and that internal links exist to change this to either of the pre fade signals. A mono sum of left and right inputs are fed to monitor sends 7/8 or 9/10 or 11/12 if they are selected as mono sends.

Monitor sends 7 through 12 can be used as stereo sends by pressing the STEREO switch on the output module. In this case the stereo input signal is fed to the bus pair via the level and pan controls. The even numbered control, for example number 8, will be used as the level control.

PRE 1-6

This sends a prefade signal to Monitors 1 through 6. Normally internal link 7 will be installed giving a pre fade post mute signal. Removing link 7 and inserting link 8 allows a pre equaliser signal to be sent.

PRE 7-10

This sends a prefade signal to Monitors 7 through 10. Normally link 3 will be installed giving the pre fade post cut signal. Removing link 3 and inserting link 4 allows the PRE1 or pre equaliser signal to be sent.

PRE 11-12

This sends a prefade signal to Monitors 11 and 12. Normally link 5 will be installed giving the pre fade post cut signal. Removing link 5 and inserting link 6 allows the pre equaliser signal to be sent.

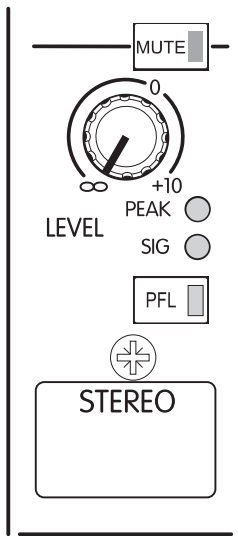

THE CHANNEL FADER

MUTE

When pressed this mutes the POST FADE signal and any POST FADE monitor sends.

LEVEL

This rotary control adjusts the post fade signal level within the module. Any monitor send receiving the post fade signal will be dependent upon this fader.

PEAK

This illuminates when the signal level is too high and close to being clipped. Clipping is a severe form of distortion and indicates that the input gain of the module should be reduced.

SIG

This illuminates in the presence of signal and may be a useful diagnostic aid in the event of any problems.

PFL

This allows the module signal to be listened to in isolation on the monitoring system. If pressed when an output AFL is active the output will be muted so that the input can be heard. When the input PFL is released the output AFL will be returned to the local monitor. This is known as input priority.

STEREO INPUT CONNECTOR AND PIN DEFINITIONS

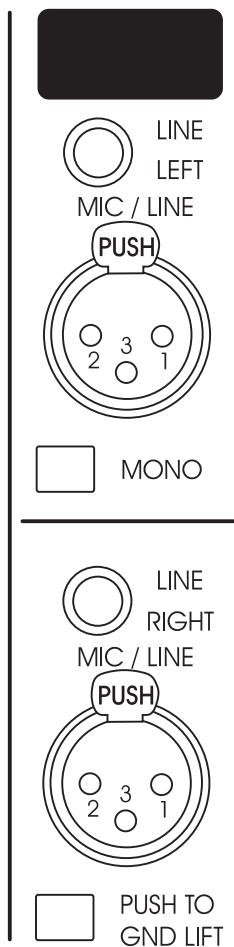

Mic Line Input : 3 Pin Female XLR type,
Balanced Pin 2 "Hot"
Nominal Input Level: -16dBu to -66dBu
Pin 2 : Signal +ve (Hot)
Pin 3 : Signal -ve (Cold)
Pin 1 : Ground
Input Impedance : >2 kOhm

Split Output : 3 Pin Male XLR type,
Balanced Pin 2 "Hot"
Nominal Output Level: -16dBu to -66dBu
Pin 2 : Signal +ve (Hot)
Pin 3 : Signal -ve (Cold)
Pin 1 : Ground

Line Input : 1/4" TRS Jack Socket, 'A' Gauge, Balanced
Nominal Input Level: -16dBu to +14dBu
Tip : Signal +ve (Hot)
Ring : Signal -ve (Cold)
Sleeve: Ground
Input Impedance : >10 kOhm

The GROUND LIFT switch isolates both the Microphone Input and the Split connector from the console ground. It may be of use when the split connector is feeding a front of house console when there is a great danger of ground loops being formed.

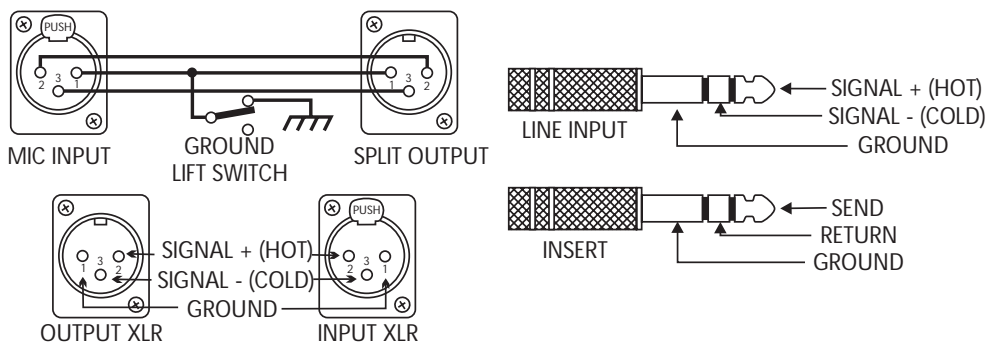

STEREO INPUT MODULE BLOCK DIAGRAM

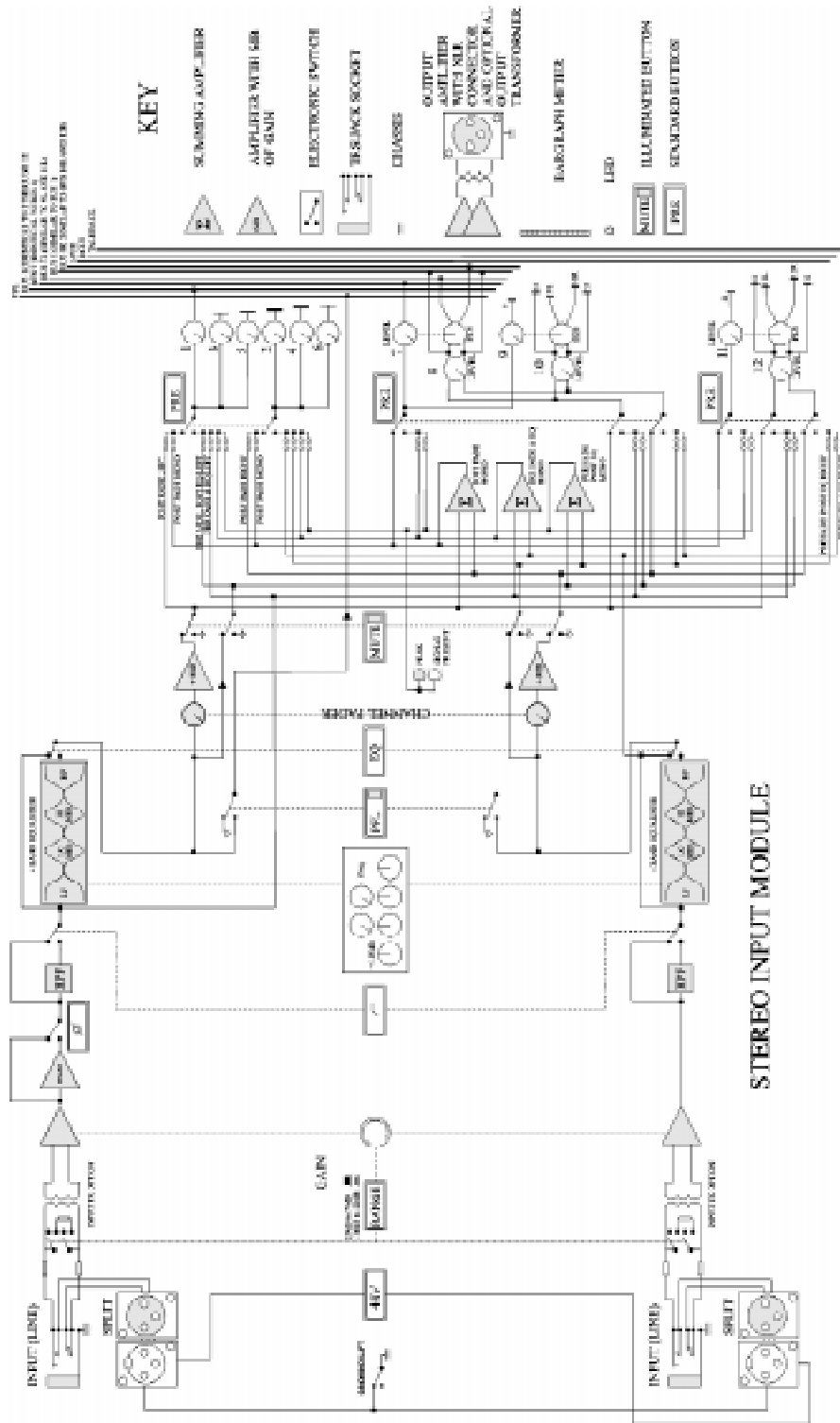

THE OUTPUT MODULE

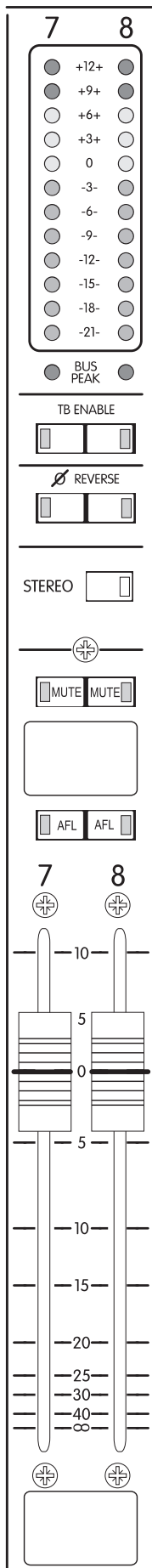

Each output module supports two monitor send outputs. The monitor sends are identical other than for the fact that the final six sends can be switched to stereo operation.

METER

A 12 segment, peak reading, bargraph meter which indicates the monitor send output level.

BUS PEAK

An led which illuminates when the mix summing amplifier is within 3dB of clipping. It means that the bus signal level is very high and in danger of being distorted. The input signals feeding the send should be reduced either by pulling down their faders or by reducing the module input gain.

T/B ENABLE

This switch preselects talkback from the master module to the monitor send output. To speak to the output the talkback key on the master module must be depressed. Note that talkback is injected after the MUTE so that if the monitor output is muted it is still possible to speak to the artist.

Ø REV

This switch reverses the phase (strictly the polarity) of the monitor send output and may be useful on occasions when feedback is troublesome.

INSERT

Although there is no front panel control associated with the INSERT POINT it is a significant part of the signal path. With no plug inserted the signal is passed through (normalled) to the insert return. If a plug is inserted the signal must travel out from the module, through some external device, and back through the insert return. This allows any signal processing on the monitor send to be done “within the console”, allowing it to be soloed and checked by the monitor engineer before being sent to its destination. The insert point is located before the fader so that as the fader is reduced any noise from the external unit will be reduced proportionally.

STEREO (OUTPUT MODULES 7-12 ONLY)

Depressing this switch changes the monitor sends located on the output modules from two mono into one stereo send. The output controls remain the same, however, the input module controls become level and pan pair rather than two level controls.

MUTE

This switch mutes the monitor output although talkback, if selected, will still be available to the output.

AFL

This enables the monitor send to be soloed. If an input solo is active it will take precedence over the output solo. Indication of an active input solo is given on the master module. Solos can be listened to on the local monitor outputs or on the headphone output. When working in stereo both AFL switches on an output module must be pressed to hear the stereo output.

FADER

This controls the level of the monitor send output. Operation close to the 0dB point is expected and any significant deviation from this means either that the bus signals are at the wrong level or the following equipment (normally a power amplifier) has an input sensitivity unsuited to the console output.

OUTPUT MODULE CONNECTOR AND PIN DEFINITIONS

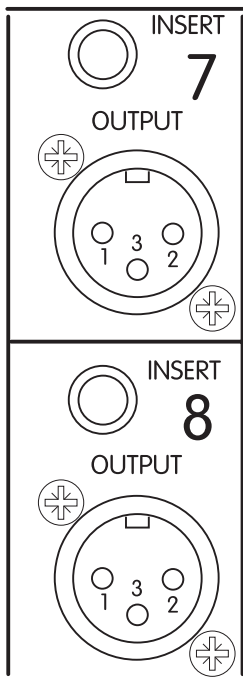

Send Output : 3 Pin Male XLR type, Balanced
Nominal Output Level: -16dBu to -66dBu
Pin 2 : Signal +ve (Hot)
Pin 3 : Signal -ve (Cold)
Pin 1 : Ground
Output Impedance: < 75 Ohm

Insert Point: 1/4" TRS Jack Socket, 'A' Gauge, unbalanced
Nominal Input/Output level: 0dBu

Tip : Insert Send
Ring : Insert Return
Sleeve: Ground
Output Impedance: <75 Ohm
Input Impedance: >10 kOhm

THE MASTER MODULE

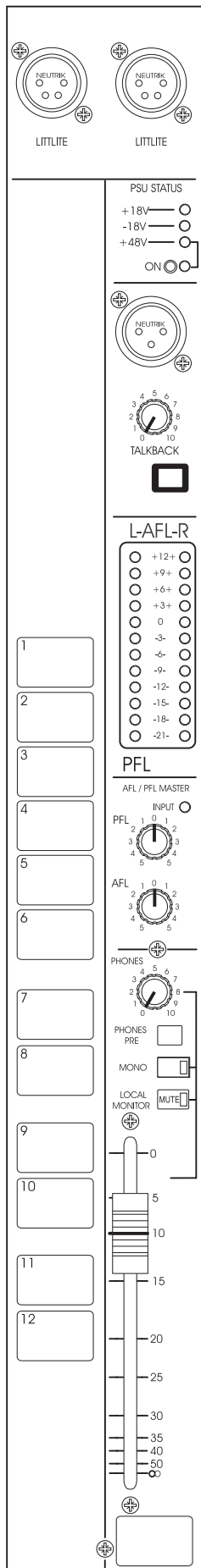

The master module allows the monitor sends to be checked by using the solo system, either through a local wedge loudspeaker or headphones. No signal will be heard until a solo is requested.

When setting up a monitor send the recommended method of working is to first of all AFL the monitor send output. Input channels can then be PFLed without releasing the output solo due to the input priority system. When an input solo is released the output solo will once again be heard. Thus an overall monitor send can be continuously checked and adjustments made to input channels by pressing only the solo for the input channel.

IDENT PADS

Each horizontal row of input send controls has an identification pad associated with it. This can be written on to assist in identifying the purpose of the sends.

LITTLITE™ CONNECTORS

Two 4 pin LITTLITE™ lamps can be plugged in here to illuminate the console.

+18 -18 +48V

These leds indicate the presence of the +18 volt rail, the -18 volt rail and the +48 volt rail. When the console is powered all three should be illuminated.

ON

This illuminates when the 48 volt supply is available to the input modules. The recessed switch can be used to switch off the 48 volts if the front of house console is being used to feed the phantom power. With the 48 volts switched off there is no possibility of any noise due to accidental operation of the phantom power switch on a module.

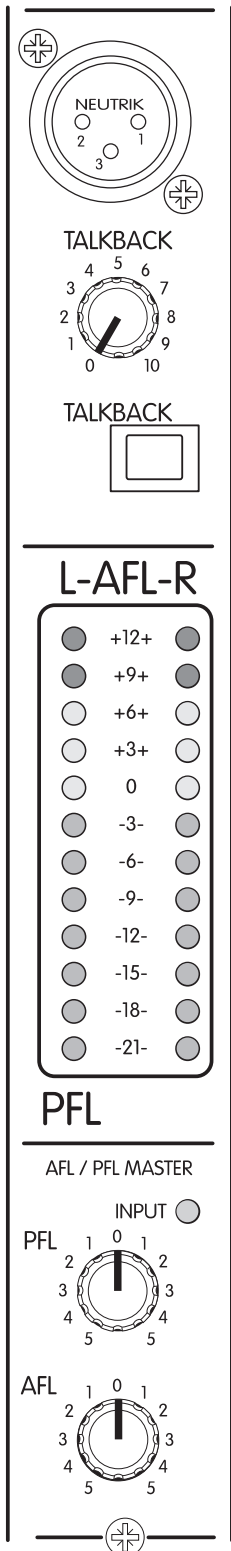

TALKBACK MICROPHONE INPUT

The talkback microphone should be plugged in here. If a phantom powered microphone is used internal link 1 must be installed. It is also possible to plug other signals in here such as an oscillator. It is also possible to feed an input from the front of house console so that the FOH engineer could talk to the sends. Make sure that the level from the oscillator or the FOH console is at a suitable level (around -50dBu). It may be necessary to use an attenuator.

TALKBACK LEVEL

This adjusts the gain of the talkback microphone amplifier.

TALKBACK

This latching switch enables talkback to any monitor output where it is pre-selected.

METERS

A pair of peak reading meters indicating the PFL/AFL levels. Input PFL will be displayed on the left meter. AFL signals from mono sends will display on both meters while AFL from stereo sends will have their left/right levels displayed. It is necessary to have both AFL buttons on a stereo send pressed to see the left and right signals or else only one or other will be displayed.

INPUT

An led indicating that an input solo (PFL) is active.

PFL

A level control to adjust the audio level of input solos (PFL). Note that this does not affect the meter readings.

AFL

A level control to adjust the audio level of output solos (AFL). Note that this does not affect the meter readings.

The AFL and PFL level controls can be used to adjust the volume of input and output solos so that they match one and other.

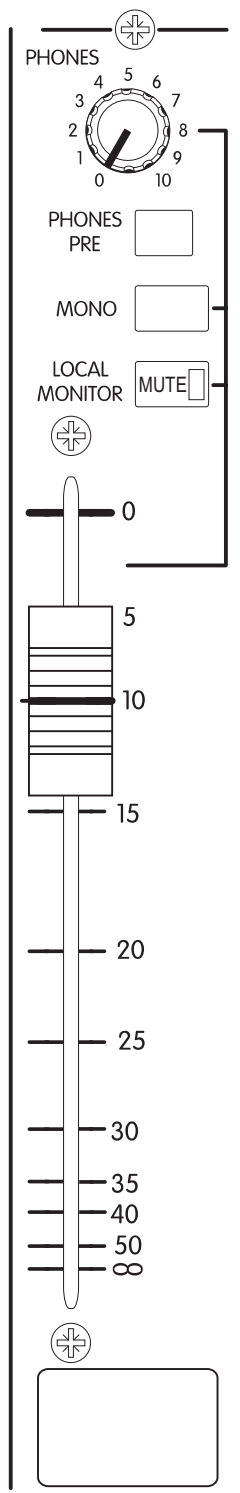

PHONES

A rotary fader controlling the signal level fed to the headphone socket. This output is suitable for driving headphones with an impedance of 100 ohms or greater. The headphone output is located below the armrest at the front of the console.

PHONES PRE

Pressing this allows the headphone output level to be adjusted independently of the local monitor output. In the normal position (UP) the headphone feed is post fader and post mute and therefore depends on the local monitor fader and mute.

MONO

This allows the monitoring system to be switched to mono, combining the left and right signals. This may be used to check the mono compatibility of a stereo send or where only one local monitor speaker is in use.

MUTE

This will mute the local monitor outputs when pressed. Note that the headphone output will also be muted by this switch unless selected PRE.

LOCAL MONITOR FADER

A linear fader controlling the level of the local wedge loudspeaker. An external amplifier is required to drive the local monitor loudspeaker. Note that unlike the remainder of the faders on the console this fader has 0dB at the top.

Note that the headphones will also be controlled by this fader when selected POST. This gives the possibility of using the headphones rotary level control to preset a level and then using the fader as a headphone level control as required.

CONNECTORS AND PIN DEFINITIONS

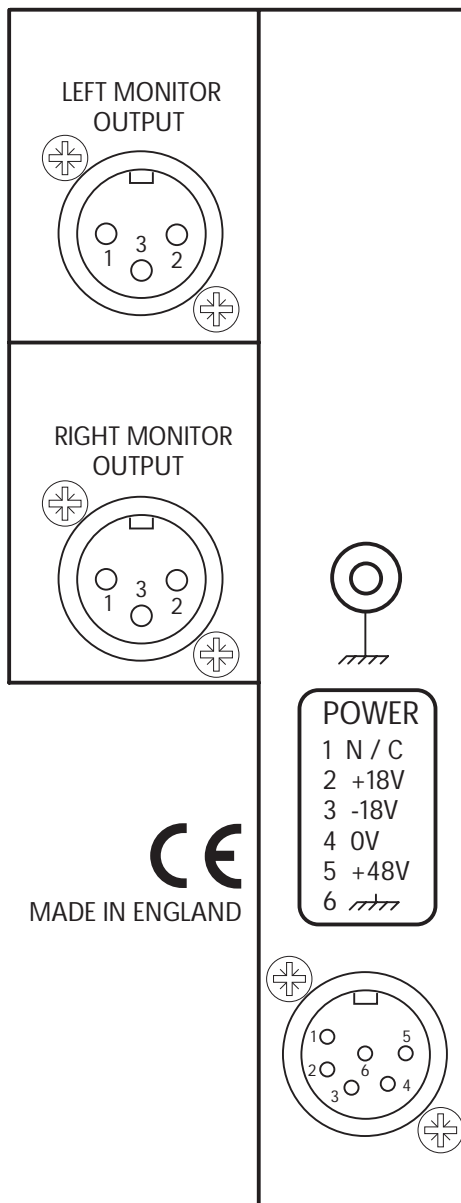

Monitor Output : 3 Pin Male XLR type,
Balanced

Nominal Output Level: -6dB

Pin 2 : Signal +ve (Hot)

Pin 3 : Signal -ve (Cold)

Pin 1 : Ground

Output Impedance: < 75 Ohms

Power Input : 6 Pin Male XLR

1 N/C

2 +18V

3 -18V

4 0V

5 +48V

6 Chassis

Ground Post

This is bonded to the console chassis.

Note that Pin 1 of all XLR connectors and the sleeves of all jack connectors are taken to chassis. 0V is not externally available.

MASTER MODULE BLOCK DIAGRAM

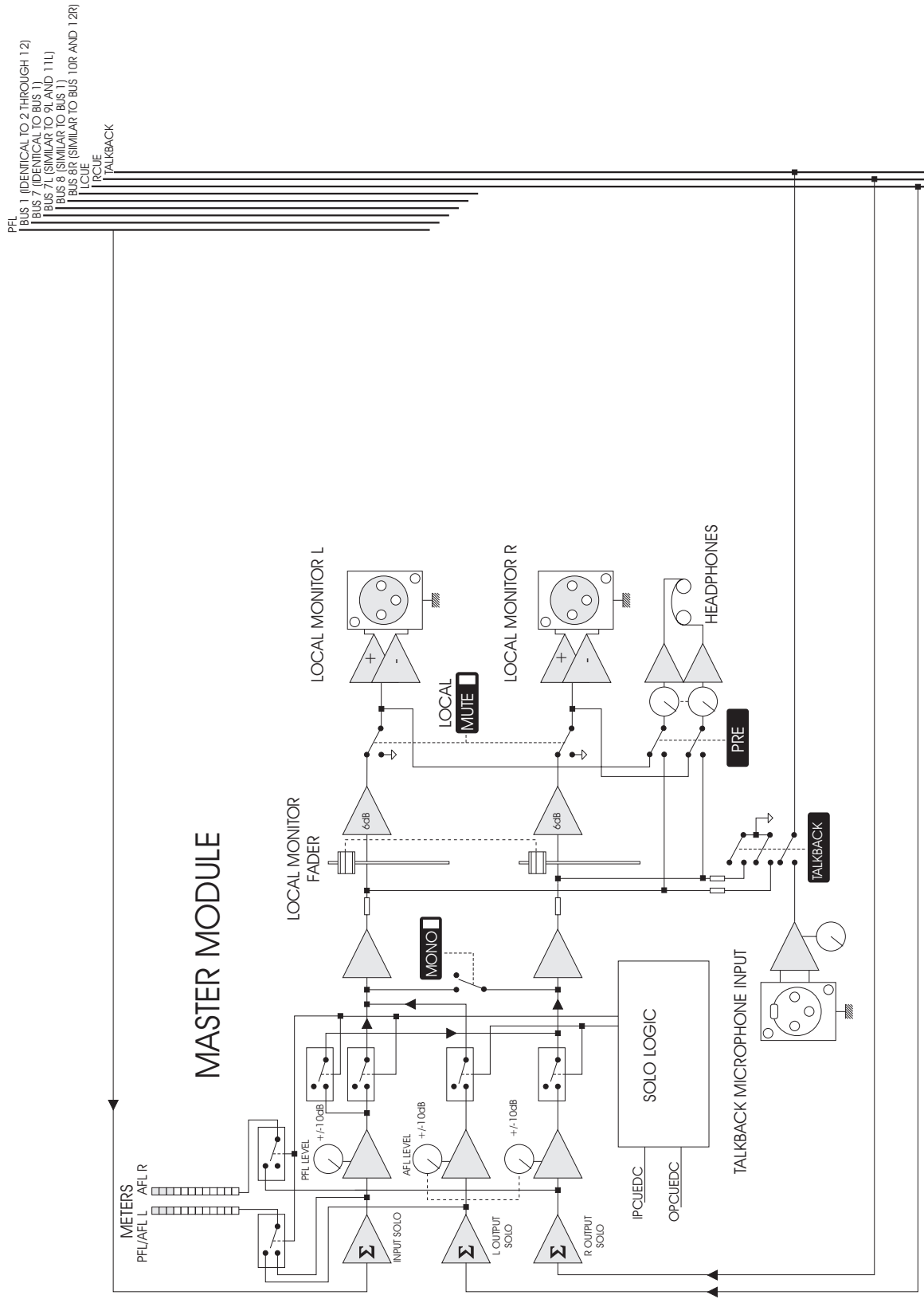

BUS LINKING

Bus linking enables a pair of CS12M consoles to be used in a master/slave configuration. Normally a rear mounted connector will link the input modules to the output modules within a console. This connector can be removed and replaced by a bus linking cable which performs differently depending upon whether the console is to be a master or a slave.

The BUS LINK facility is located on the rear of the frame below the master module. Access is made by removing the BUS LINK panel to expose a connector with a handle. Pull this connector away from the console and plug in the appropriate end of the linking cable depending upon whether the console is to be a master or a slave. Similar action should be taken on the second console using the other end of the linking cable.

If a console is to be a master then use the master end of the bus link cable which maintains the link between the input and the output modules. The cable then connects the input modules from the slave console onto the master console buses.

If a console is to be a slave console then use the slave end of the cable which breaks the link between the input and output modules and connects the input modules over to the buses of the master console. The master and output modules of this console are now disabled.

The ground cable should always be connected to both consoles using the ground studs on the rear panels of the consoles.

When linked operation is no longer required the link cable should be removed from both consoles and the original connectors replaced. It is strongly recommended that the cover plates are then replaced to prevent the ingress of electromagnetic interference.

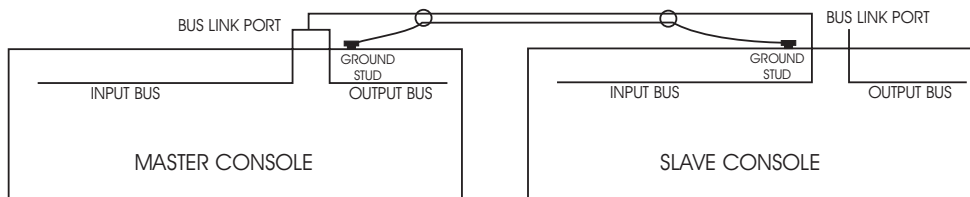

The above illustration shows how the link cable joins the input modules of the slave console to the output modules of the master console.

THE POWER SUPPLY

The interface type power supply for the console is a back mounted unit and operates from either 230V or 120V AC, 50-60Hz, occupying 2U of space. Clearance should be allowed in the rack such that sufficient cooling can take place — 2U above the unit is suggested.

The outputs are rated as follows :-

+/-18V at 4.0 Amps maximum
+48V at 350mA maximum.

The outputs are electronically protected and in the event of a shut down the supply must be switched off to reset it. The positive and negative rails track so that if one fails the other will shut down to minimise any damage caused to the console. The output cable is captive and 3 metres long.

DC Pinout

1 Not connected
2 +18 Volts
3 -18 Volts
4 0 Volts
5 +48 Volts
6 Chassis

The power supply carries the following approvals:-
CSA, UL, IEC95 and conforms to the EC Directive for Electromagnetic Compatibility.

Always connect the power supply to the console and the electricity supply before switching on.

Fusing:

230V	CSM02-0017	2.5A 20mm S/B Fuse	(I.E.C.)
120V	CSM02-0016	2.5A 20mm S/B Fuse	(U/L)
100V	CSM02-0006	3.15A 20mm S/B Fuse	(PSU400J only)

INSTALLATION GUIDE

There are a number of points to consider when installing a mixing console. Many of these points will have been addressed before the console is even unpacked but it is worth repeating them again.

POSITION

The console should be located in a convenient space commensurate with the use to which the console is being put. Ideally a cool area is preferred not in close proximity to power distribution equipment or other potential sources of interference. Provision should be made for some flat surface surrounding the console to prevent people using it as a table top. One of the worst fates that can befall a console is for a cup of coffee to be tipped into it by someone resting it on the control surface!

POWER

The power supply should be located as far from the console as the connecting cable will allow. It should be set for the appropriate line voltage and plugged into the mains outlet using the supplied cable.

WIRING

The console uses three different connector styles:-

TRS jack sockets, XLR male connectors and XLR female connectors.

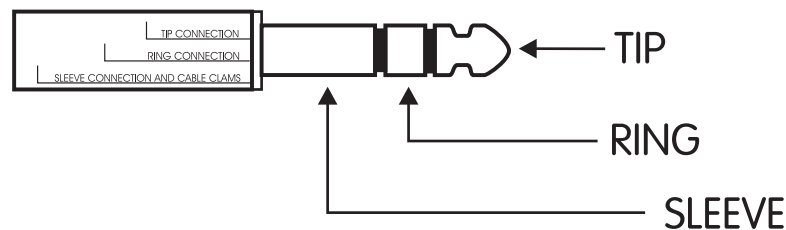

1/4 INCH TRS "A" GAUGE JACK PLUG

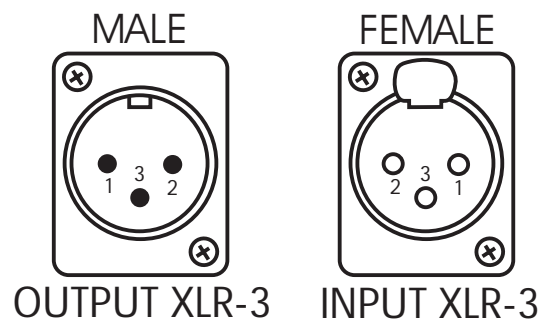

OUTPUT XLR-3

INPUT XLR-3

The cables used should be of as high a quality as possible. Many installation problems can be traced back to poor or faulty cables and connectors.

As mentioned before there are two different conventions for the wiring of XLR connectors. The international convention uses pin 2 as the hot pin while the older American convention uses pin 3 as the hot pin. When going from balanced input to balanced output this is of little consequence but when unbalanced signals such as those found on the insert points are used then phase reversal can result. The CS12MONITOR and all DDA products are wired PIN 2 HOT.

ATTENTION

CABLES

This product should only be used with high quality, screened twisted pair audio cables, terminated with metal bodied 3-pin XLR connectors. The cable shield should be connected to Pin 1. Any other cable type or configuration for the audio signals may result in degraded performance due to electromagnetic interference.

ELECTRIC FIELDS

Should this product be used in an electromagnetic field that is amplitude modulated by an audio frequency signal (20Hz - 20kHz), the signal to noise ratio may be degraded. Degradation of up to 60dB at a frequency corresponding to the modulation signal may be experienced under extreme conditions (3V/m, 90% modulation).

No permanent damage or degradation of performance will be caused by these conditions.

CS12M GROUNDING

The following illustration shows the grounding system of the CS12Monitor console. There are several points to note as follows:-

For safety reasons the power company ground is bonded to the power supply chassis and connected through to the chassis of the console. This should never be disconnected.

There is no direct connection between chassis and 0 Volts (Audio Ground)

0 Volts (Audio Ground) is not externally available on the console.

Pin 1 of all XLR style connectors is connected to chassis.

The sleeve of all jack connectors is connected to chassis.

The chassis ground is effectively forming a continuous shield covering the electronics and the cable carrying the signal between them.

Ground lift switches are provided on the microphone inputs and split outputs so that when the console is used in conjunction with a front of house (FOH) console and there are any grounding problems then isolation can be achieved between the grounding systems.

If the ground lift is operative then phantom power should be supplied from the front of house console and the master phantom switch on the CS12Monitor console can be switched off.

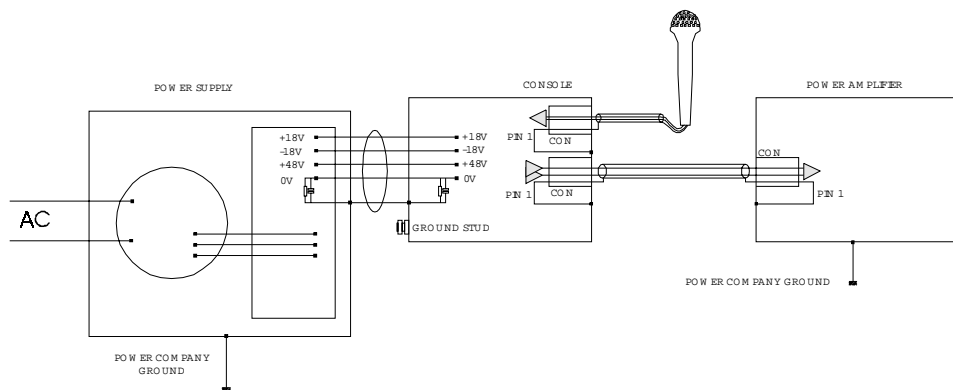

TUTORIAL

The role of the monitor console is fundamentally different from that of the front of house console in that it must produce a large number of distinct mixes of equal relative importance. In contrast the front of house console produces one main mix with several, arguably less important, mixes for sending to effect units. The CS12M console has the capacity to produce 12 monitor mixes which are in effect the group outputs of the console.

Why the need for a monitor console in the first place ?

It is obviously very important for musicians playing together to be able to hear one and other. Before the advent of large public address (P.A.) systems bands would have the instrument amplification behind them and everyone on stage would have the ability to hear at least a rough mix of the sound. As more and more instruments began to be put through increasingly large P.A. systems the soundfield on stage became less representative of what was really happening “out front”, and loudspeakers were required on stage to recreate the sound lost from the instrument amplifiers. A refinement of this idea gave musicians individual monitor feeds by having their own loudspeaker which would be supplied with a mix adjusted to their specific requirements. This loudspeaker is usually referred to as a wedge owing to its distinctive shape. This comes about as a result of the directivity required of the speaker from its position close to the feet of the artist it is serving.

It is important for the monitor engineer to have a local monitor, usually a wedge, allowing access to the mixes through the solo function which is critical to the operation of the console. To aid the engineer the solo system has input priority meaning that if an input PFL is selected while an output AFL is active the output AFL will be suspended. When the input PFL is cancelled the output AFL is returned to the local monitor output. This allows quick and intuitive operation with a useful reduction in the number of button pushes required.

Stereo or mono ?

Before the advent of in ear monitoring mono monitor feeds were adequate. With the introduction of in ear wireless systems stereo monitor mixes became a reality and this facility had to be available on the monitor console. The CS12M allows six of the monitor sends to be switched for either mono or stereo operation.

Routing

The routing on the monitor console is more akin to the auxiliary send facility of other consoles as it is usually done with rotary potentiometers and switches. The potentiometers are used to create the mix to a monitor send or group output and a monitor console is likely to have a large number of knobs.

Pre or Post fade ?

The monitor feeds may be switched either pre or post fader. With POST FADE selected then the sends will depend upon the channel fader. With PRE selected, links enable the sends to be sourced either pre equaliser or pre fade — post cut. The sends can all be operated either pre or post fade without a great deal of difference although it may be useful to switch a stereo send to PRE, if, for example, it is to be used as a sidefill. Alternatively the rest of the console could be switched to PRE and the sidefill taken from a post fade stereo send.

Insert Points

The monitor outputs are equipped with insert points allowing the insertion of equalisers and other equipment into the monitor output signal path. This has a great advantage over the more conventional approach of placing this equipment in between the monitor output and the power amplifier as it allows the effect to be monitored by the engineer. It can thus be accurately set up without the need for semaphore signals from the stage area !

Meters

All monitor outputs are metered to show the level from that output. Peak meters give a truer indication of the actual signal level and this means that the signal can be run “hotter” than with VU meters improving the signal to noise ratio of the console.

Auxiliary Functions

The monitor console may also have to perform other functions including splitting the microphone feeds from the stage to send to the front of house console as well as the monitor console. If this was not the case two microphones would be required - one feeding the front of house console and the other feeding the monitor console. Every input module in the CS12M has a second XLR which carries the output of a microphone splitter which is integral with the module. A ground lift switch is provided to assist with any problems that may arise when the split output is used.

The CS12M console has the ability to feed phantom power to the microphones although often the front of house engineer will prefer to send the phantom power from his console. If phantom power is not required on the CS12M console it can be switched off completely using the recessed switch on the master module. Thus if any of the input phantom switches are pressed accidentally there will be no thump or click while the master power is off.

If an artist does not receive the correct foldback or monitor mix then the performance of that artist may suffer, consequently the foldback or monitor mix is much more important than might at first be imagined. The balance of the performer to the rest of the ensemble in the monitor mix must be correct otherwise pitching difficulties may be encountered while a lack of ambience or reverberation can also affect the amount of life that a performer is able to inject into a performance. It is also easier to follow a beat when the rhythm instruments are in mono. Traditional monitoring relies on stage mounted loudspeakers usually fed from mono signal sources and although supplying the artists with the required foldback there are many drawbacks. Not least is the high level of sound on stage which can interfere with the front of house sound and introduce feedback.

In ear monitoring was developed in the late 1980's to overcome some of the problems inherent with traditional stage monitoring practices. Usually a number of Wedge Monitor Speakers are used, one positioned in front of each artist, and fed with a mix adjusted to the requirements of that artist. Thus on a busy stage there could be as many as 16 wedges all carrying different mixes. In addition there may even be sidefills to give coverage of the stage area with no wedges facilitating movement of the artists without losing their monitor feed. It can be deduced that the stage, under these circumstances, can be a very noisy area with a great deal of interaction occurring between the different monitor mixes. The monitor engineer may have to constantly adjust several monitor mixes in order to track an artist moving around the stage.

There are several problems here.

- Health and safety - whereby the artists are being subjected to high sound pressure levels
- Imprecision of the monitor mix actually received by the artist
- The sound on stage increases the risk of feedback and will also spill to affect the front of house sound.
- Distortion from the monitor loudspeakers entering the microphones which feed the front of house system which reduces the clarity of the sound.

While the monitor engineer has the ability to solo a monitor mix on his console this does not necessarily coincide with the mix heard by an artist on stage who is probably receiving spills from other monitor mixes in addition the intended one. In ear monitoring addresses these concerns by providing a barrier to external sounds thus enabling the artist to hear a much more precise monitor mix.

As the mix is now heard in comparative isolation the monitor engineer then has a much clearer idea of what the artist is receiving and consequently can adjust the mix much more precisely. In fact the monitor engineer may have his own in ear system allowing auditioning of precisely the same signal as is sent to an artist.

In ear monitoring uses the good fit of the earpieces to provide a high degree of attenuation to external sounds. In top flight systems the earpieces can be custom moulded to the exact shape of an artist's ear. Bone conduction will obviously not allow sounds to be completely attenuated but it will be sufficient to enable a monitor mix to be accurately heard while attenuating other sounds. It can be expected that the monitor sound will now be at a lower level than that coming from a wedge. Some artists, notably bass players and drummers like to "feel" the sound, sometimes referred to as "trouser flapping", and this is one area where in ear monitoring cannot compete. In these instances a sub woofer can be supplied feeding the low frequencies to the performer. For a drummer the sub woofer could be placed under the drum riser while a bass player could stand close to, or even upon, his instrument's loudspeaker cabinet. It is even possible to buy a drum stool with built in loudspeaker.

One of the great advantages of radio links is the mobility they bestow and a combination of in ear monitoring with a radio microphone allows a performer to go virtually anywhere within a performance area. This not only improves the lot of the monitor engineer by reducing the workload but also dramatically improves the quality of the monitor sound received by the artist improving in turn the quality of their performance.

As with everything in life there are a number of basic rules to be followed for optimum results and these can summarised as follows.

Never try and set up the system on a new user. This is akin to equalising a monitor wedge with an artist standing in front of it. They do not like it !

Always start with the simplest mix you think you can get away with and run the system as quietly as possible. This way the artist can cue from the mix and blend into the ambient sound of the band. Add more into the mix as you acquire confidence.

Add some reverberation - a dry sound is very unnatural. As a starting point try using the large room or small hall settings at 1.6 seconds reverberation with the sibilance taken out. Reverberation can be of great benefit when assisting those with pitching difficulties.

Try to maximise the signal into the system without overloading it. Retain line of site paths between transmitters and receivers for best reception.

The last two points will help maintain the signal to noise ratio of the wireless link.

There is a psycho-acoustic phenomenon whereby the person making a sound perceives that sound as quieter than another person hearing it (the Stapedius muscle reflex). This often accounts for the volume battles between musicians on stage. In setting up your mix, the ratio of a voice to the backing mix for example, will be much higher than you would normally expect. Keep the backing mix low and the vocals well out in front.

Many singers more to used to working with wedges can be overcome by the power of in ear monitoring. Consequently they sing more quietly, which although beneficial for their voice, can sometimes lead to front of house gain problems. The solution here is to turn the monitor level down either at the belt pack or at the input to the system.

Be aware that any adjustments made to the monitor mix will be clearly heard - do not change the mix unless you absolutely have to.

Many thanks to Garwood Communications Ltd., makers of the RADIO STATION In Ear Monitoring System, for the above information.

A TYPICAL SETUP

The following illustration shows what might be the setup for a seven piece band. Inputs to the console are as follows :-

Vocal Microphone
3 Backing Vocal Microphones
Guitar Cabinet Microphone
Rhythm Guitar Direct Inject
Bass Cabinet Microphone
Keyboard 1 Direct Inject Feed (Stereo)
Keyboard 2 Direct Inject Feed (Stereo)
Keyboard 3 Direct Inject Feed (Stereo)
7 Drum Kit Microphones as follows :-
 Kick
 Snare
 Hi Hat
 Rack Toms
 Floor toms
 Overhead Mic
 Overhead Mic
5 Percussion Microphones as follows :-
 Conga Lo
 Conga Hi
 Bongos
 Sampler
 Overhead Mic
Effect Return (2 channels)
Saxophone A
Saxophone B Direct Inject

A total of 29 inputs are being used and therefore the console is likely to be at least a 32 input version. This still leaves a few spare channels in the event of an additional input being required.

There are three wedges on stage which will use 3 of the mono sends on the console. The vocalist, guitarist and keyboard player have all elected to use stereo in ear monitoring thereby using a total of 6 sends combined to give three stereo sends. The drummer is going to use a mono wired in ear feed in addition to his wedge. At least one of the mono sends is used to feed an effect unit such as a reverberation device which is returned into the monitor console for sending to the monitor feeds.

As you can see it does not take long to use all the monitor outputs but with careful planning the number of sends could be reduced if really necessary by sending one output to more than one destination. The drummer may for example want the same feed on his wedge as on his in ear monitor.

There are many possible variations on this theme and it is therefore very difficult to give hard and fast rules as to how the console is best used. As shown above sometimes stereo monitoring is not required and this releases another send on the console for use on another monitor mix.

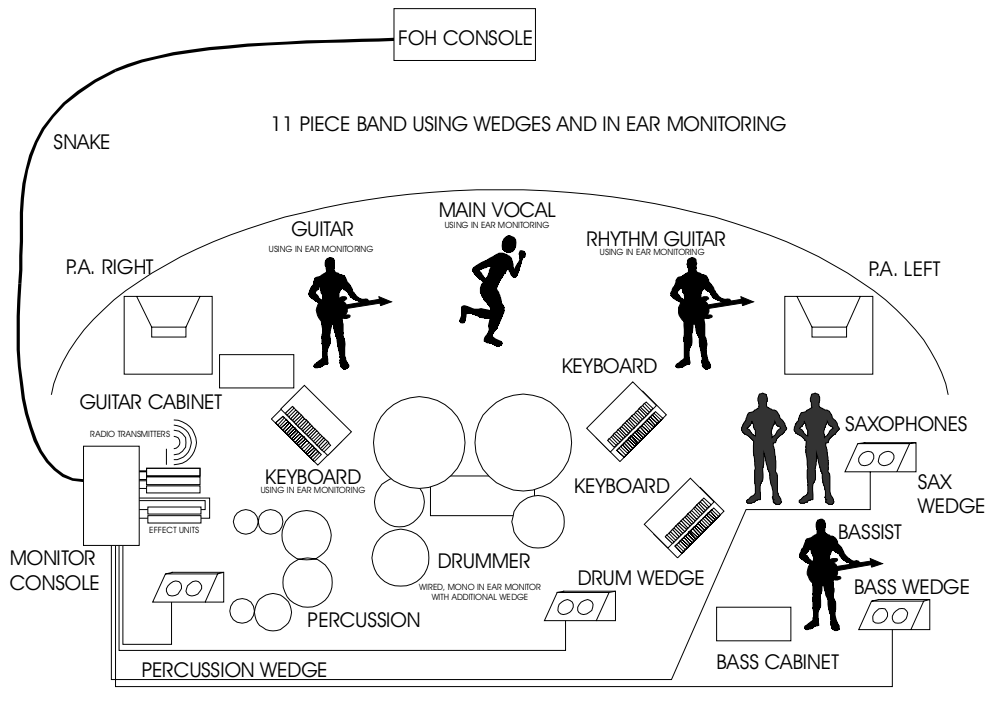

POSITIONING THE WEDGES

It may sound obvious but if an artist is to properly hear a monitor feed then they must be located within the primary soundfield of the speaker and located close to it because of the high ambient stage levels. It is equally important to prevent the monitor feed from going where it is not wanted such as into the microphones and from this it follows that the wedges should be placed within the dead area of any nearby microphone's response. For this reason microphones with a cardioid response are recommended rather than omnidirectional microphones.

Feedback may still be a problem and a first line of defence is to use the PHASE (polarity) reversal switch associated with the monitor send. This will cause the direct microphone signal and the monitor signal to cancel (assuming that this is not already happening due a phase reversal somewhere else in the system) thereby increasing the margin before feedback occurs. There are phase reverse switches located on the input modules and their use is best restricted to correcting the polarity of any microphones that are out of phase with respect to the others.

Where reversing the send polarity does not give enough level before feedback there is a technique known as "Ringing Out" that can be used to increase the feedback margin.

RINGING OUT

Ring out uses an equaliser, usually a one third octave graphic type, located in the feed to the monitor loudspeaker. The monitor send insert point can be used for this purpose allowing the effect of any equalisation to be checked through the AFL system.

With the stage set up as for the performance go through one send at a time doing the following :-

Turn up a monitor send until feedback occurs with someone speaking into a microphone routed to that send. Using an audio spectrum analyser locate the howl round frequency and reduce the level, at that frequency on the graphic equaliser, by 3-4dB. If a spectrum analyser is unavailable you can boost the frequencies one at a time on the graphic equaliser to find the ones that cause feedback at a low boost setting — they can then be reduced in gain as in the previous method. Increase the monitor level until feedback then re-occurs with someone speaking into the microphone. If it occurs at the same frequency pull it down by a few more decibels on the equaliser. If at a different frequency then pull down this new frequency by 3-4dB.

You will reach a point where pulling down individual frequencies no longer works as there are many frequencies causing the howl round simultaneously. This is the time to call it a day and move onto the next monitor feed using the same procedure.

The input channel High Pass Filters can also be used to clean up the sound and assist in preventing feedback by reducing vocal popping and any sound transmitted through the stage and up the microphone stand. Remember that their effect will be heard on all the monitor sends that the microphone is routed to.

A feedback safety margin should always be left as there will be a major difference between the sound check and the actual performance. This margin will allow the monitors to be turned up as and when the stage performance swings into life without the risk of feedback.

RECOMMENDED AUXILIARY EQUIPMENT

The following items of equipment referred to in the preceding articles may be of use when setting up a monitor system.

Klark Teknik DN360 Graphic Equaliser

This is a dual channel 30 band graphic equaliser offering 12dB of boost and cut in one third octave steps between 25Hz and 20kHz.

Klark Teknik DN3600 Programmable Graphic Equaliser

This is similar to the DN360 but offers digital control and storage of up to 66 equalisation programs.

Klark Teknik DN6000 Audio Analyser

This incorporates a Pink Noise Generator and will be found useful for identifying feedback frequencies. It may also be used for setting up the front of house system.

GLOSSARY

This section provides a simple explanation of some of the terms used when describing the console features.

“A” GAUGE JACK

This is a 1/4" jack which has a large tip diameter compared with a “B” gauge jack which has a smaller diameter tip and is usually found in broadcast use. Both types could be described as TRS (Tip, Ring, Sleeve) and it is the A Gauge that is used on DDA product.

AFL

After Fade Listen. For listening to post fade signals - those controlled by a fader.

AUXILIARY SENDS

These are extra signal paths out of the console which are separate from the main mix and group outputs. Each auxiliary output is like a separate mixer and can be controlled independently of the main faders. They are used to provide special mixes to artists as they are recording (normally called FOLDBACK) or as a signal to be sent to an effect such as a reverberation or delay device.

BUS

This is the term used to describe the summing or mixing of a number of signals. A number of signals routed to the same bus will appear as one signal at the output of the bus mixing amplifier.

BUS TRIM

A control used to adjusted the level of all signals going to a Group Output.

CHANNEL PATH

The path used by the signal going to tape in an in-line console.

D.I.

Direct Inject is an input used for high level devices such as keyboards where the line input would not be sensitive enough.

DIM

This reduces the monitor level by a preset amount, usually 20dB in DDA products.

DIRECT OUTPUT

This refers to the individual output of a channel which is available even if the channel is not routed.

EBO

Electronically Balanced Output.

EQ

Equaliser or Tone Control.

FOLDBACK

This is the signal which is usually fed to the artists headphones.

GROUND SENSING OUTPUT

An output stage where any ground noise is injected into the feedback loop in such a way that it appears in phase on the amplifier output. As the ground should be the reference for the following stage, if it is moving and the signal is moving in the same way then no net signal results.

GROUP OUTPUT

An output usually routed to a multitrack tape recorder input. This output is derived from a bus and one group output stage is required for each bus.

HF

High Frequency

HIGH PASS FILTER (HPF)

A filter which cuts out frequencies below its operating frequency. It can be used to filter out rumble picked up by a microphone for example.

IN EAR MONITORING

A monitoring system using specially designed earphones as opposed to loudspeakers

INSERT POINT

Sometimes referred to as a patch point. This is an interruption to the signal path to allow for the insertion of a signal processing device.

INTERMISSION PLAYBACK

This allows a signal to be played out from the master outputs of the console with the master faders closed thus preventing stage microphones or other signal sources from reaching the master outputs.

LF

Low Frequency.

LINE INPUT

An input designed to accept high level signals as opposed to microphone level signals. The expected level is usually +4dBu but increasingly inputs and outputs are being designed so that they can be altered to operate at -10dBV which is now quite a common operating level.

LOW PASS FILTER (LPF)

This is the inverse of a HIGH PASS filter and is used to reduce frequencies above the operating frequency

MASTER

This normally refers to the main stereo output section which controls the level of the stereo mix and associated functions such as monitoring.

MIX PATH

The path used by the signal going to the stereo mix.

PARAMETRIC EQ

An equaliser section which has variable frequency, level and Q.

PAN

A pan control or Pan Pot or Panoramic Potentiometer is used to spread a mono signal across multiple buses.

PEAKING EQ

In this form of equaliser the response is tailored to enhance a selected frequency relative to the frequencies above and below it. Peaking equalisers are normally used as the mid sections of an equaliser. Also known as "bell shaped".

PFL

Pre Fade Listen. For listening to pre fade signals.

POST-FADER

A signal derived after a fader and therefore dependant upon the position of the fader.

PRE-FADER

A signal derived before a fader and therefore not dependant upon the position of the fader.

Q

Associated with peaking equalisers the Q is the factor which describes how wide the peak or trough of enhancement is. The smaller the Q the wider the bandwidth of the equaliser will be. Typically a fixed Q equaliser will have a Q of about 1.5 equating to a bandwidth of about 1 octave.

QUASI BALANCED

An arrangement whereby a bus is terminated with a differential input. The bus however is not truly balanced, instead a bus common is used to pick up any interference which will also be picked up by the true bus. The interference then appears as a common mode signal at the mixing amplifier.

RETURN

Any signal that is sent out of the console and is returned after some form of processing.

ROUTING

The sending of a signal to a bus normally by pressing a switch. Signal can be routed to several buses simultaneously if required.

SCRIBBLE STRIP

An area of the console reserved for the user to write on, usually in order to identify channel usage.

SEND

The output from a channel insert point is called the (insert) send.

SHELVING EQ

This means that the response of the equaliser becomes constant after the turnover or corner frequency has been passed. Thus a high frequency shelving equaliser operating at 10kHz will have a rising response as the frequency approaches 10kHz but will be flat after 10kHz. This is normally used on the high and low frequency sections of an equaliser.

SIDEFILL

A mix, usually in stereo, used as a general monitor mix across the stage and provided by loudspeakers situated to the left and right of the stage area. The sidefill mix is usually sourced from the stereo mix output of the monitor console.

SIP

Solo in Place. This is a solo mode which cuts all the input channels that are not soloed leaving the console monitor system listening to the stereo bus. The mix bus now contains only signal from the soloed channel and therefore the SIP mode can be potentially dangerous to use in a live situation. By comparison AFL and PFL usually work by switching the monitoring system to listen to the solo buses. The mix bus signal is unchanged.

SLATE

The ability to talk to tape from the operating position of the console.

SOLO

The function of monitoring one input, group or monitor output of the console in isolation.

SWEEP FREQUENCY

A control which selects a centre frequency to operate around. Most often used with peaking equalisers but it can also be used to determine the roll off point of shelving EQs as well.

TRS JACK

A Tip, Ring, Sleeve 'A' gauge jack.

VCA

Voltage Controlled Amplifier. An amplifier whose gain can be controlled by a DC Voltage applied to its control port.

WEDGE

The name given to an individual's monitoring loudspeaker due to its distinctive shape. The baffle is angled to direct the sound up toward the players head.

WRITING STRIP

See scribble strip.

XLR

The XLR (in fact a specific manufacturer's model reference) is an industry standard connector of high quality and is normally used for balanced signals, primarily microphones and balanced outputs. The most common is a three pin version, although there are types with more pins for other purposes. In fact XLR is derived from eXtra Low Resistance !

WARRANTY

If within a period of three years from the date of delivery of the equipment to the End User it shall prove defective by reason only of faulty materials and/or workmanship (but not faulty design) to such an extent that the effectiveness and/or the usability thereof is materially affected, the Equipment or the faulty component shall be returned to the Distributor or DDA and subject to the following conditions the Distributor or DDA will repair or at its option replace the defective components. Any components replaced will become the property of DDA.

Any Equipment or component returned will be at the risk of the End User whilst in transit (both to and from the Distributor or DDA) and postage and/or freight charges must be prepaid.

This Warranty shall only be available if:-

- i) The Equipment has been properly installed in accordance with the instructions contained in this manual.
- ii) The End User has notified the Distributor or DDA in writing within 14 days of the defect appearing.
- iii) No persons other than authorised representatives of DDA or the Distributor have effected any replacement of parts, maintenance adjustments or repairs to the Equipment.
- iv) The End User has used the Equipment for such purposes as DDA recommends with only such operating supplies as meet DDA's specifications or approval and otherwise in all respects in accordance with DDA's recommendations.

Defects arising as a result of the following are not covered by this Warranty :-

Faulty or negligent handling, chemical or electro-chemical or electrical influences, accidental damage, Acts of God, neglect, deficiency in electrical power, air conditioning or humidity control.

Benefit of this Warranty may not be assigned by the End User. End Users who are consumers should note that their rights under this Warranty are in addition to and do not affect any other rights to which they may be entitled against the seller of the Equipment.

DDA shall not be liable for any damage caused to persons or property due to :-

- i) Incorrect usage of the Equipment
- ii) Other equipment attached to the Equipment, which is not approved by DDA
- iii) Modifications made by non-authorised persons, or by using non-recommended parts, or incorrectly made.

In no circumstances shall DDA be liable for any indirect or consequential costs, damages or losses (including loss of business profits, operating time or otherwise) arising out of the use or inability to use the product, whether or not the likelihood of damage was advised to DDA or its distributor.

Fuses and filament lamps are specifically excluded from this warranty.

This notice does not affect your statutory rights.

Declaration of Conformity

The Manufacturer of the Products covered by this Declaration is

EVI Audio

Klark Teknik Building, Walter Nash Road, Kidderminster,
Worcestershire, DY11 7HJ.

The Directives Covered by this Declaration.

89/336/EEC Electromagnetic Compatibility Directive, amended by 92/31/EEC & 93/68/EEC
73/23/EEC Low Voltage Equipment Directive, amended by 93/68/EEC.

The Products Covered by this Declaration.

Model CS3 Mixing Console.
Model CS8 Mixing Console.
Model CS12M Mixing Console.

The Basis on which Conformity is being Declared

The products identified above comply with the protection requirements of the EMC Directive and with the principal elements of the safety objectives of the Low Voltage Directive, and the manufacturer has applied the following standards:

EN 55013 : 1990

Limits and methods of measurement of radio disturbance characteristics of Broadcast Receivers and Associated Equipment.

EN55020 : 1988

Sound and Television Broadcast Receivers and Associated Equipment, Electromagnetic Compatibility.

EN 60065 : 1994

Safety requirements for mains operated electronic related apparatus for household and similar general use.

The technical documentation required to demonstrate that the products meet the requirements of the Low Voltage Directive has been compiled by the signatory below and is available for inspection by the relevant enforcement authorities. The CE mark was first applied in 1996

Signed:



G.M.Squires

Authority:

Product Support Manager.

Date:

1st, January 1997.

Attention

The attention of the specifier, purchaser, installer, or user is drawn to special measures and limitations to use which must be observed when these products are taken into service to maintain compliance with the above directives. Details of these special measures and limitations to use are available on request, and are also contained in product manuals.